



CI-V REFERENCE GUIDE

VHF/UHF ALL MODE TRANSCEIVER

IC-9700

Icom Inc.

Table of contents

Remote control	2
■ Remote control (CI-V) information	2
◇ CI-V connection	2
◇ Preparing	3
◇ About the data format	3
◇ Command table	4
◇ Command formats	13

Remote control

Remote control (CI-V) information

◇ CI-V connection

The transceiver's operating frequency, mode, VFO and memory selection, can be remotely controlled using a PC. The Icom Communications Interface V (CI-V) controls the transceiver.

Select your connection method from the following:

• A USB cable (A-B type, user supplied)

The required USB driver and driver installation guide can be downloaded from the Icom web site.

Go to "<http://www.icom.co.jp/world/Support>," and then click "Firmware Updates / Software downloads."

① The download procedure on the web page may be changed without notice.

① Make the connection as short as possible. The transceiver may not be recognized by the controller, depending on the USB cable length.

• Connection example

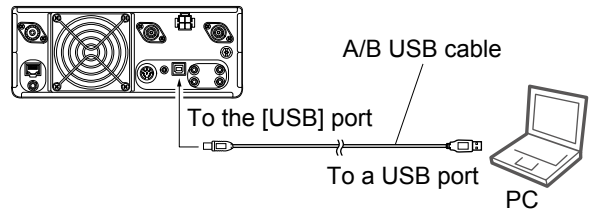

• The optional OPC-2350LU (DATA CABLE)

NOTE: Before you start sending data, be sure to set the following items.

- Set "DATA Function" to "CI-V."
(SET > Connectors > USB (B)/DATA Function)

• Connection example

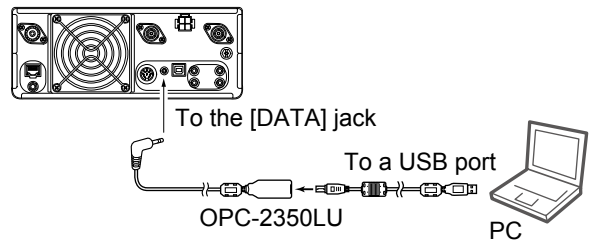

• The optional CT-17 (CI-V LEVEL CONVERTER)

Connects to a PC with an RS-232C port.

• Connection example

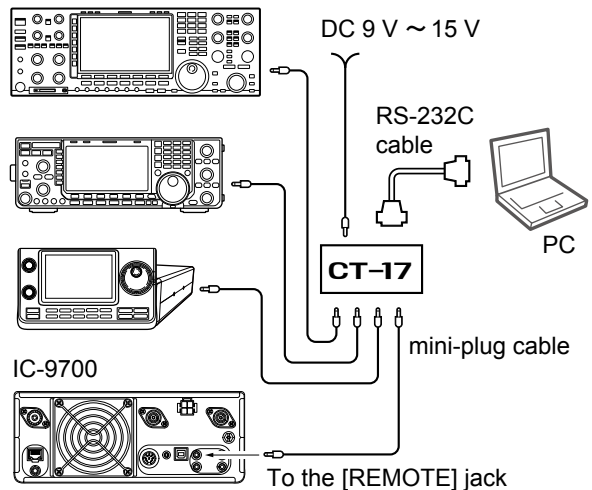

Remote control

Remote control (CI-V) information(Continued)

◇ Preparing

The Icom Communications Interface V (CI-V) is used for remote control. To control the transceiver, first set its address, data communication speed, and transceive function. These settings are set in the Set mode (Refer to the IC-9700 instruction manual).

◇ About the data format

The CI-V system can be written using the following data formats. Data formats differ according to command numbers. A data area or sub command is added for some commands.

Controller to IC-9700

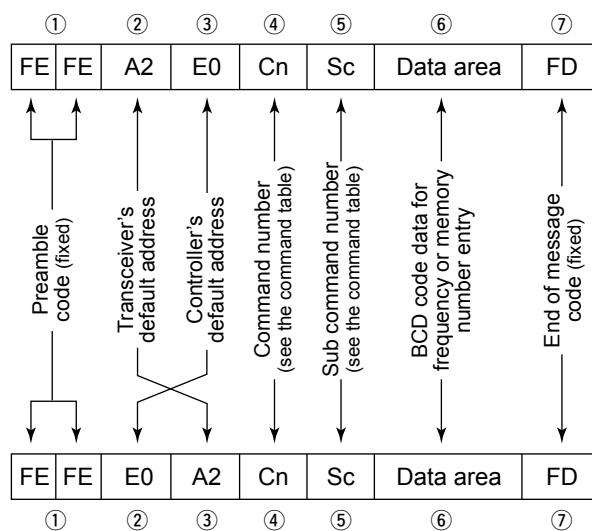

IC-9700 to controller

OK message to controller

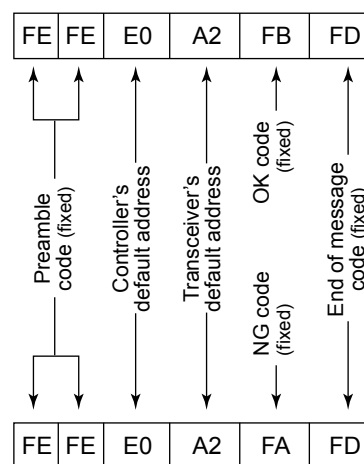

NG message to controller

Remote control

NOTE: Operation of some control dials overrides CI-V commands. If a control dial, such as the AF Volume dial that has a mark on it, is rotated after sending a CI-V command, the command will be overwritten by the operation.

◇ Command table

Cmd.	Sub cmd.	Data	Description
00		See p. 13	Send the frequency data (transceiver)
01		See p. 13	Send the mode data (transceiver)
02 ^{*1}		See p. 13	Read the band edge frequencies
03 ^{*1}		See p. 13	Read the operating frequency
04 ^{*1}		See p. 13	Read the operating mode
05 ^{*2}		See p. 13	Set the operating frequency
06 ^{*2}		See p. 13	Set the operating mode
07			Select the VFO mode
	00		Select VFO A (In the satellite mode, selects the VFO mode.)
	01		Select VFO B (In the satellite mode, "FA" (NG) is returned.)
	A0		Equalize VFO A and VFO B
	B0		Exchange MAIN and SUB Bands
	D0		Select the main band
	D1		Select the sub band
	D2 [*]	00	Send/read main band selection
	01	Send/read sub band selection	
08 ^{*2}			Select the Memory mode
		0001 to 0099	Select the Memory channel (Including the satellite mode) (0001=M-CH01, 0099=M-CH99)
		0100 to 0105	Select program scan edge channel 1A/1B to 3A/3B (0100/0101 (1A ch/1B ch), 0104/0105 (3A ch/3B ch))
		0106, 0107	Select call channel C1/C2 (0106 (C1 ch), 0107 (C2 ch))
09			Memory write
0A			Memory copy to VFO
0B			Memory clear
0C ^{*1}		See p. 13	Read frequency offset
0D ^{*2}		See p. 13	Send frequency offset
0E	00		Cancel the scan
	01		Start a Programmed/memory scan
	02		Start a Programmed scan
	03		Start a ΔF scan
	12		Start a Fine programmed scan
	13		Start a Fine ΔF scan
	22		Start a Memory scan
	23		Start a Select memory scan
	24		Start a Mode Select scan
	Ax ^{*2} (x=1 to 7)		Select ΔF scan span (x=1 (±5 kHz), x=2 (±10 kHz), x=3 (±20 kHz), x=4 (±50 kHz), x=5 (±100 kHz), x=6 (±500 kHz), x=7 (±1 MHz))
	B0 ^{*2}		Clear the Select channel setting
	B1 ^{*2}		Set as select channel (The previously set number by CI-V is set after turning power ON, or "1" is selected if no selection is performed.)
		01 to 03	Set the channel as a Select channel (01=SEL1, 02=SEL2, 03=SEL3)
	B2 ^{*2}	00 to 03	Set the Select memory scan channel (00=ALL, 01=SEL1, 02=SEL2, 03=SEL3)
D0 ^{*2}		Set Scan resume OFF	
D3 ^{*2}		Set Scan resume ON (Close&Delay)	
0F	1	00	Read Split OFF setting
		01	Read Split ON setting
		11	Read DUP- operation
		12	Read DUP+ operation
		13	Read DD Repeater Simplex mode (RPS)
	00 ^{*2}		Set Split function OFF
	01 ^{*2}		Set Split function ON

Cmd.	Sub cmd.	Data	Description
0F	10 ^{*2}		Set the simplex operation
	11 ^{*2}		Set DUP- operation
	12 ^{*2}		Set DUP+ operation
	13 ^{*2}		Set DD Repeater Simplex mode (RPS)
10 [*]		00 to 11	Send/read the tuning step (00=OFF (10 Hz or 1 Hz), 01=100 Hz, 02=500 Hz, 03=1 kHz, 04=5 kHz, 05=6.25 kHz, 06=10 kHz, 07=12.5 kHz, 08=20 kHz, 09=25 kHz, 10=50 kHz, 11=100 kHz)
	11 [*]	00	Send/read attenuator OFF setting
10		Send/read 10 dB attenuator setting	
13	00		Speech all data with voice synthesizer (S meter level, frequency and mode)
	01		Speech the operating frequency and S meter level by voice synthesizer
	02		Speech the operating mode by voice synthesizer ① The mode is announced after the ongoing speech.
14 [*]	01	0000 ~ 0255	Send/read the AF level (0000=Minimum to 0255=Maximum)
	02	0000 ~ 0255	Send/read the RF gain level (0000=Minimum to 0255=Maximum)
	03	0000 ~ 0255	Send/read the squelch level (0000=Minimum to 0255=Maximum)
	06	0000 ~ 0255	Send/read the NR level (0000=0%, 0255=100%)
	07	0000 ~ 0255	Send/read [TWIN PBT] (PBT1) position (0000=max. Counter Clockwise, 0128=center, 0255=max. Clockwise)
	08	0000 ~ 0255	Send/read [TWIN PBT] (PBT2) position (0000=max. Counter Clockwise, 0128=center, 0255=max. Clockwise)
	09	0000 ~ 0255	Send/read CW pitch (5 Hz steps) (0000=300 Hz, 0128=600 Hz, 0255=900 Hz)
	0A	0000 ~ 0255	Send/read RF power (0000=Minimum to 0255=Maximum)
	0B	0000 ~ 0255	Send/read MIC gain (0000=Minimum to 0255=Maximum)
	0C	0000 ~ 0255	Send/read keying speed (0000=6 WPM to 0255=48 WPM)
	0D	0000 ~ 0255	Send/read Notch filter setting (0000=max. Counter Clockwise, 0128=center, 0255=max. Clockwise)
	0E	0000 ~ 0255	Send/read the COMP level (0000=0 to 0255=10)
	0F	0000 ~ 0255	Send/read the Break-IN Delay setting (0000=2.0 d to 0255=13.0 d)
	12	0000 ~ 0255	Send/read NB level (0000=0% to 0255=100%)
	15	0000 ~ 0255	Send/read Monitor audio [MONI] level (0000=0% to 0255=100%)
	16	0000 ~ 0255	Send/read the VOX gain (0000=0% to 0255=100%)
	17	0000 ~ 0255	Send/read the Anti VOX gain (0000=0% to 0255=100%)
	19	0000 ~ 0255	Send/read LCD backlight brightness (0000=0% to 0255=100%)
	15 ^{*1}	01	00 or 01
02		0000 to 0255	Read S-meter level (0000=S0, 0120=S9, 0241=S9+60 dB)
05		00 or 01	Read various squelch (tone squelch, and so on) status (00=Close, 01=Open)
07		00 or 01	Read the OVF status (00=OVF indicator is OFF, 01=OVF indicator is ON)
11		0000 ~ 0255	Read the PO meter level (0000=0% to 0143=50% to 0213=100%)

Remote control

◇ Command table (Continued)

Cmd.	Sub cmd.	Data	Description
15 ¹	12	0000 ~ 0255	Read SWR meter level (0000=SWR1.0, 0048=SWR1.5, 0080=SWR2.0, 0120=SWR3.0)
	13	0000 ~ 0255	Read ALC meter level (0000=Minimum to 0120=Maximum)
	14	0000 ~ 0255	Read COMP meter level (0000=0 dB, 0130=15 dB, 0210=25.5 dB)
	15	0000 ~ 0255	Read Vd meter level (0000=0 V, 0013=10 V, 0241=16 V)
	16	0000 ~ 0255	Read Id meter level (0000=0 A, 0121=10 A, 0241=20 A)
16 [*]	02	00 to 03	Send/read the Preamp/External Preamp (00=P.AMP (OFF)/EXT-P.AMP (OFF), 01=P.AMP (ON)/EXT-P.AMP (OFF), 02=P.AMP (OFF)/EXT-P.AMP (ON), 03=P.AMP (ON)/EXT-P.AMP (ON))
	12	01 to 03	Send/read the AGC time constant (01=FAST, 02=MID, 03=SLOW)
	22	00 or 01	Send/read the Noise blanker (00=OFF, 01=ON)
	40	00 or 01	Send/read the Noise reduction (00=OFF, 01=ON)
	41	00 or 01	Send/read the Auto Notch function (00=OFF, 01=ON)
	42	00 or 01	Send/read the Repeater tone (00=OFF, 01=ON)
	43	00 or 01	Send/read the Tone squelch (00=OFF, 01=ON)
	44	00 or 01	Send/read the Speech compressor (00=OFF, 01=ON)
	45	00 or 01	Send/read the Monitor [MONI] function (00=OFF, 01=ON)
	46	00 or 01	Send/read the VOX function (00=OFF, 01=ON)
	47	00 to 02	Send/read the BK-IN function (00=BK-IN OFF, 01=Semi BK-IN ON, 02=Full BK-IN ON)
	48	00 or 01	Send/read the Manual Notch function (00=OFF, 01=ON)
	4A	00 or 01	Send/read the AFC function (00=OFF, 01=ON)
	4B	00 or 01	Send/read the DTCS function (00=OFF, 01=ON)
	4F	00 or 01	Send/read the Twin peak filter (00=OFF, 01=ON) (Can be turned ON only when Mark and Shift are set to 2125 Hz and 170 Hz, respectively)
	50	00 or 01	Send/read the Dial lock function (00=OFF, 01=ON)
	56	00 or 01	Send/read the DSP IF filter type (00=SHARP, 01=SOFT)
	57	00 to 02	Send/read the Manual Notch width (00=WIDE, 01=MID, 02=NAR)
	58	00 to 02	Send/read SSB transmit bandwidth (00=WIDE, 01=MID, 02=NAR) (One of following values is applied, depending on the "COMP" status (ON or OFF): WIDE (Command: 1A 05 0017), MID (Command: 1A 05 0018) or NAR (Command: 1A 05 0019))
	59	00 or 01	Send/read the sub band (the Dualwatch function) (00=OFF, 01=ON)
	5A	00 or 01	Send/read the satellite mode (00=OFF, 01=ON)
	5B	00 to 02	Send/read the DSQL (Digital Call Sign squelch)/CSQL (Digital Code squelch) setting (DV mode only) (00=OFF, 01=DSQL, 02=CSQL)
	5C	00 to 02	Set the GPS TX mode (00= OFF, 01= D-PRS, 02= NMEA)
		00 to 03, 06 to 09	Set the Tone squelch function (00=OFF, 01=TONE, 02=TSQL, 03=DTCS, 06=DTCS (T), 07=TONE (T)/DTCS (R), 08=DTCS (T)/TSQL (R), 09=TONE (T)/TSQL (R))
	65	00 or 01	Set the IP Plus function (00=OFF, 01=ON)

Cmd.	Sub cmd.	Data	Description	
17 ³		See p. 10	Send CW messages	
18	00		Turn OFF the transceiver	
	01 ⁴		Turn ON the transceiver	
19 ¹	00		Read the transceiver ID	
1A [*]	00	See pp. 14, 15	Send/read memory contents	
	01	See p. 15	Send/read band stacking register contents	
	02 ⁵	See pp. 15, 16	Send/read memory keyer contents	
	03	See p. 16	Send/read the selected IF filter width	
	04	See p. 16	Send/read the selected AGC time constant	
	05	0001	See p. 16	SET > Tone Control/TBW > RX > Send/read SSB RX HPF/LPF settings
		0002	00 to 10	SET > Tone Control/TBW > RX > Send/read SSB RX Tone (Bass) level (00=-5 to 10=+5)
		0003	00 to 10	SET > Tone Control/TBW > RX > Send/read SSB RX Tone (Treble) level (00=-5 to 10=+5)
		0004	See p. 16	SET > Tone Control/TBW > RX > Send/read AM RX HPF/LPF settings
		0005	00 to 10	SET > Tone Control/TBW > RX > Send/read AM RX Tone (Bass) level (00=-5 to 10=+5)
		0006	00 to 10	SET > Tone Control/TBW > RX > Send/read AM RX Tone (Treble) level (00=-5 to 10=+5)
		0007	See p. 16	SET > Tone Control/TBW > RX > Send/read FM RX HPF/LPF settings
		0008	00 to 10	SET > Tone Control/TBW > RX > Send/read FM RX Tone (Bass) level (00=-5 to 10=+5)
		0009	00 to 10	SET > Tone Control/TBW > RX > Send/read FM RX Tone (Treble) level (00=-5 to 10=+5)
		0010	See p. 16	SET > Tone Control/TBW > RX > Send/read DV RX HPF/LPF settings
		0011	00 to 10	SET > Tone Control/TBW > RX > Send/read DV RX Tone (Bass) level (00=-5 to 10=+5)
		0012	00 to 10	SET > Tone Control/TBW > RX > Send/read Auto DV RX Tone (Treble) level (00=-5 to 10=+5)
		0013	See p. 16	SET > Tone Control/TBW > RX > Send/read CW RX HPF/LPF settings
		0014	See p. 16	SET > Tone Control/TBW > RX > Send/read RTTY RX HPF/LPF settings
		0015	00 to 10	SET > Tone Control/TBW > TX > Send/read SSB TX Tone (Bass) level (00=-5 to 10=+5)
		0016	00 to 10	SET > Tone Control/TBW > TX > Send/read SSB TX Tone (Treble) level (00=-5 to 10=+5)
		0017	See p. 16	SET > Tone Control/TBW > TX > Send/read SSB TX bandwidth for wide
		0018	See p. 16	SET > Tone Control/TBW > TX > Send/read SSB TX bandwidth for mid
		0019	See p. 16	SET > Tone Control/TBW > TX > Send/read SSB TX bandwidth for narrow
		0020	See p. 16	SET > Tone Control/TBW > TX > SSB-D TX passband width
		0021	00 to 10	SET > Tone Control/TBW > TX > Send/read AM TX Tone (Bass) level (00=-5 to 10=+5)
0022		00 to 10	SET > Tone Control/TBW > TX > Send/read AM TX Tone (Treble) level (00=-5 to 10=+5)	
0023		00 to 10	SET > Tone Control/TBW > TX > Send/read FM TX Tone (Bass) level (00=-5 to 10=+5)	
0024		00 to 10	SET > Tone Control/TBW > TX > Send/read FM TX Tone (Treble) level (00=-5 to 10=+5)	
0025		00 to 10	SET > Tone Control/TBW > TX > Send/read DV TX Tone (Bass) level (00=-5 to 10=+5)	
0026		00 to 10	SET > Tone Control/TBW > TX > Send/read DV TX Tone (Treble) level (00=-5 to 10=+5)	

Remote control

◇ Command table (Continued)

Cmd.	Sub cmd.	Data	Description	
1A*	05	0027	0000 ~ 0255 SET > Function > Beep Level (0000=Minimum to 0255=Maximum)	
		0028	00 or 01 SET > Function > Beep Level Limit (00=OFF, 01=ON)	
		0029	00 or 01 SET > Function > Beep (Confirmation) (00=OFF, 01=ON)	
		0030	00 or 01	SET > Function > Band Edge Beep (00=OFF, 01=ON) (ON = Beep sounds with a default amateur band)
			02	SET > Function > Band Edge Beep (02=ON (User))
			03	SET > Function > Band Edge Beep (03=ON (User) & TX Limit)
		0031	0050 ~ 0200 SET > Function > Beep Sound (MAIN) (0050=500 Hz to 0200=2000 Hz)	
		0032	0050 ~ 0200 SET > Function > Beep Sound (SUB) (0050=500 Hz to 0200=2000 Hz)	
		0033	00 or 01 SET > Function > Sub Band Mute (TX) > Speaker/Phones (00=OFF, 01=ON)	
		0034	00 or 01 SET > Function > Sub Band Mute (TX) > USB (00=OFF, 01=ON)	
		0035	00 or 01 SET > Function > Sub Band Mute (TX) > LAN (00=OFF, 01=ON)	
		0036	00 to 02 SET > Function > RF/SQL Control (00=Auto, 01=SQL, 02=RF+SQL)	
		0037	00 or 01 SET > Function > FM/DV Center Error function (00=OFF, 01=ON)	
		0038	00 to 05 SET > Function > TX Delay > 144M (00=OFF, 01=10 ms, 02=15 ms, 03=20 ms, 04=25 ms, 05=30 ms)	
		0039	00 to 05 SET > Function > TX Delay > 430M (00=OFF, 01=10 ms, 02=15 ms, 03=20 ms, 04=25 ms, 05=30 ms)	
		0040	00 to 05 SET > Function > TX Delay > 1200M (00=OFF, 01=10 ms, 02=15 ms, 03=20 ms, 04=25 ms, 05=30 ms)	
		0041	00 to 05 SET > Function > Time-Out Timer (00=OFF, 01=3 min., 02=5 min., 03=10 min., 04=20 min., 05=30 min.)	
		0042	00 or 01 SET > Function > PTT Lock (00=OFF, 01=ON)	
		0043	00 or 01 SET > Function > SPLIT > Quick SPLIT (00=OFF, 01=ON) (Setting the [SPLIT] key operation when it is held down for 1 second.)	
		0044	See p. 16 SET > Function > SPLIT > FM SPLIT Offset	
		0045	00 or 01 SET > Function > SPLIT > SPLIT LOCK (00=OFF, 01=ON)	
		0046	00 or 01 SET > Function > Auto Repeater (00=OFF, 01=ON (DUP,TONE) for USA version)	
		0047	00 to 02 SET > Function > RTTY Mark Frequency (00=1275 Hz, 01=1615 Hz, 02=2125 Hz)	
		0048	00 to 02 SET > Function > RTTY Shift Width (00=170 Hz, 01=200 Hz, 02=425 Hz)	
		0049	00 or 01 SET > Function > RTTY Keying Polarity (00=Normal, 01=Reverse)	
		0050	00 or 01 SET > Function > SPEECH > SPEECH Language (00=English, 01=Japanese)	
		0051	00 or 01 SET > Function > SPEECH > Alphabet (00=Normal, 01=Phonetic Code)	
		0052	00 or 01 SET > Function > SPEECH > SPEECH Speed (00=Slow, 01=Fast)	
		0053	00 to 02 SET > Function > SPEECH > RX Call Sign SPEECH (00=OFF, 01=ON (Kerchunk), 02=ON (All))	
		0054	00 or 01 SET > Function > SPEECH > RX>CS SPEECH (00=OFF, 01=ON)	
		0055	00 or 01 SET > Function > SPEECH > S-Level SPEECH (00=OFF, 01=ON)	

Cmd.	Sub cmd.	Data	Description
1A*	05	0056	00 or 01 SET > Function > SPEECH > MODE SPEECH (00=OFF, 01=ON)
		0057	0000 ~ 0255 SET > Function > SPEECH > SPEECH Level (0000=0% to 0255=100%)
		0058	00 or 01 SET > Function > [SPEECH/LOCK] Switch (00=SPEECH/LOCK, 01=LOCK/SPEECH)
		0059	00 or 01 SET > Function > Lock Function (00=MAIN DIAL, 01=ANEL)
		0060	00 or 01 SET > Function > Memo Pad Quantity (00=5 ch, 01=10 ch)
		0061	00 to 02 SET > Function > MAIN DIAL Auto TS (00=OFF, 01=Low, 02=High)
		0062	00 or 01 SET > Function > MIC Up/Down Speed (00=Slow, 01=Fast)
		0063	00 or 01 SET > Function > AFC Limit (00=OFF, 01=ON)
		0064	00 to 02 SET > Function > [NOTCH] Switch (SSB) (00=Auto, 01=Manual, 02=Auto/Manual)
		0065	00 to 02 SET > Function > [NOTCH] Switch (AM) (00=Auto, 01=Manual, 02=Auto/Manual)
		0066	00 or 01 SET > Function > SSB/CW Synchronous Tuning (00=OFF, 01=ON)
		0067	00 or 01 SET > Function > CW Normal Side (00=LSB, 01=USB)
		0068	00 or 01 SET > Function > Screen Keyboard Type (00=Ten-key, 01=Full Keyboard)
		0069	00 to 02 SET > Function > Screen Full Keyboard Layout (00=English, 01=German, 02=French)
		0070	00 or 01 SET > Function > Screen Capture [POWER] Switch (00=OFF, 01=ON)
		0071	00 or 01 SET > Function > Screen Capture File Type (00=PNG, 01=BMP)
		0072	0000 ~ 0255 SET > Function > REF Adjust (0000=0%, 0255=100%)
		0073	0000 ~ 0255 SET > Function > REF Adjust (FINE) (0000=0%, 0255=100%)
		0074	00 to 03 SET > DV/DD Set > Standby Beep (00=OFF, 01=ON, 02=ON (to me: High Tone), 03=ON (to me: Alarm/High Tone))
		0075	00 to 02 SET > DV/DD Set > Auto Reply (00=OFF, 01=ON, 02=Voice)
		0076	00 or 01 SET > DV/DD Set > DV Data TX (00=PTT 01=Auto)
		0077	00 or 01 SET > DV/DD Set > DV Fast Data > Fast Data (00=OFF, 01=ON)
		0078	00 or 01 SET > DV/DD Set > DV Fast Data > GPS Data Speed (00=Slow, 01=Fast)
		0079	00 to 10 SET > DV/DD Set > DV Fast Data > TX Delay (PTT) (00=OFF, 01=1 sec. to 10=10 sec.)
		0080	00 to 02 SET > DV/DD Set > Digital Monitor (00=Auto, 01=Digital, 02=Analog)
		0081	00 or 01 SET > DV/DD Set > Digital Repeater Set (00=OFF, 01=ON)
		0082	00 or 01 SET > DV/DD Set > DV Auto Detect (00=OFF, 01=ON)
		0083	00 or 01 SET > DV/DD Set > RX Record (RPT) (00=ALL, 01=Latest Only)
		0084	00 or 01 SET > DV/DD Set > BK (00=OFF, 01=ON)
		0085	00 or 01 SET > DV/DD Set > EMR (00=OFF, 01=ON)
		0086	0000 ~ 0255 SET > DV/DD Set > EMR AF Level (0000=0%, 0255=100%)
		0087	00 or 01 SET > DV/DD Set > DD TX Inhibit (Power ON) (00=OFF, 01=ON)
0088	00 or 01 SET > DV/DD Set > DD Packet Output (00=Normal, 01=All)		
0089	00 or 01 SET > QSO/RX Log > QSO Log (00=OFF, 01=ON)		

Remote control

◇ Command table (Continued)

Cmd.	Sub cmd.	Data	Description
1A*	05	00 or 01	SET > QSO/RX Log > RX History Log (00=OFF, 01=ON)
		0091	00 to 02 SET > QSO/RX Log > CSV Format > Separator/Decimal (00=Separator is “.” and Decimal is “.,” 01=Separator is “;” and Decimal is “;,” 02=Separator is “,” and Decimal is “,”)
		0092	00 to 02 SET > QSO/RX Log > CSV Format > Date (00=“yyyy/mm/dd,” 01=“mm/dd/yyyy,” 02=“dd/mm/yyyy”)
		0093	00 or 01 SET > Connectors > External P.AMP > 144M (00=OFF, 01=ON)
		0094	00 or 01 SET > Connectors > External P.AMP > 430M (00=OFF, 01=ON)
		0095	00 or 01 SET > Connectors > External P.AMP > 1200M (00=OFF, 01=ON)
		0096	00 or 01 SET > Connectors > External Speaker Separate (00=Separate, 01=Mix)
		0097	00 to 30 SET > Connectors > Phones > Level (00=-15 dB to 30=+15 dB)
		0098	00 to 02 SET > Connectors > Phones > L/R Mix (00=Separate, 01=Mix, 02=Auto)
		0099	00 or 01 SET > Connectors > ACC AF/IF Output > AF/SQL Output Select (00=MAIN, 01=SUB)
		0100	00 or 01 SET > Connectors > ACC AF/IF Output > Output Select (00=AF, 01=IF)
		0101	0000 ~ 0255 SET > Connectors > ACC AF/IF Output > AF Output Level (0000=0% to 0255=100%)
		0102	00 or 01 SET > Connectors > ACC AF/IF Output > AF SQL (00=OFF (Open), 01=ON)
		0103	00 or 01 SET > Connectors > ACC AF/IF Output > AF Beep/Speech... Output (00=OFF, 01=ON)
		0104	0000 ~ 0255 SET > Connectors > ACC AF/IF Output > ACC IF Output Level (0000=0% to 0255=100%)
		0105	00 or 01 SET > Connectors > USB AF/IF Output > Output Select (00=AF, 01=IF)
		0106	0000 ~ 0255 SET > Connectors > USB AF/IF Output > AF Output Level (0000=0%, 0255=100%)
		0107	00 or 01 SET > Connectors > USB AF/IF Output > AF SQL (00=OFF (Open), 01=ON)
		0108	00 or 01 SET > Connectors > USB AF/IF Output > AF Beep/Speech... Output (00=OFF, 01=ON)
		0109	0000 ~ 0255 SET > Connectors > USB AF/IF Output > IF Output Level (0000=0%, 0255=100%)
		0110	00 or 01 SET > Connectors > LAN AF/IF Output > Output Select (00=AF, 01=IF)
		0111	00 or 01 SET > Connectors > LAN AF/IF Output > AF SQL (00=OFF (Open), 01=ON)
		0112	0000 ~ 0255 SET > Connectors > MOD Input > ACC MOD Level (0000=0% to 0255=100%)
		0113	0000 ~ 0255 SET > Connectors > MOD Input > USB MOD Level (0000=0% to 0255=100%)
		0114	0000 ~ 0255 SET > Connectors > MOD Input > LAN MOD Level (0000=0% to 0255=100%)
		0115	00 ~ 05 SET > Connectors > MOD Input > DATA OFF MOD (00=MIC, 01=ACC, 02=MIC,ACC, 03=USB, 04=MIC,USB, 05=LAN)
		0116	00 ~ 05 SET > Connectors > MOD Input > DATA MOD (00=MIC, 01=ACC, 02=MIC,ACC, 03=USB, 04=MIC,USB, 05=LAN)

Cmd.	Sub cmd.	Data	Description
1A*	05	0117	00 or 01 SET > Connectors > ACC SEND Output > 144M (00=OFF, 01=ON)
		0118	00 or 01 SET > Connectors > ACC SEND Output > 430M (00=OFF, 01=ON)
		0119	00 or 01 SET > Connectors > ACC SEND Output > 1200M (00=OFF, 01=ON)
		0120	00 to 04 SET > Connectors > USB SEND/Keying > USB SEND (00=OFF, 01=USB(A) DTR, 02=USB(A) RTS, 03=USB(B) DTR, 04=USB(B) RTS) (You cannot select the same setting for USB keying (CW) or USB keying (RTTY).)
		0121	00 to 04 SET > Connectors > USB SEND/Keying > USB Keying (CW) (00=OFF, 01=USB(A) DTR, 02=USB(A) RTS, 03=USB(B) DTR, 04=USB(B) RTS) (You cannot select the same setting for USB SEND.)
		0122	00 to 04 SET > Connectors > USB SEND/Keying > USB Keying (RTTY) (00=OFF, 01=USB(A) DTR, 02=USB(A) RTS, 03=USB(B) DTR, 04=USB(B) RTS) (You cannot select the same setting for USB SEND.)
		0123	00 or 01 SET > Connectors > USB SEND/Keying > Inhibit Timer at USB connection (00=OFF, 01=ON)
		0124	00 or 01 SET > Connectors > External Keypad > VOICE (00=OFF, 01=ON)
		0125	00 or 01 SET > Connectors > External Keypad > KEYS (00=OFF, 01=ON)
		0126	00 or 01 SET > Connectors > External Keypad > RTTY (00=OFF, 01=ON)
		0127	00 or 01 SET > Connectors > CI-V > CI-V Transceive (00=OFF, 01=ON)
		0128	0000 ~ 0223 SET > Connectors > CI-V > CI-V USB/LAN→REMOTE Transceive Address (0000=00h to 0223=DFh in Hexadecimal)
		0129	00 or 01 SET > Connectors > CI-V > CI-V USB Port (00=Link to [REMOTE], 01=Unlink to [REMOTE])
		0130	00 or 01 SET > Connectors > CI-V > CI-V USB Echo Back (00=OFF, 01=ON)
		0131	00 or 01 SET > Connectors > CI-V > CI-V DATA Echo Back (00=OFF, 01=ON)
		0132	00 to 02 SET > Connectors > CI-V > USB (B)/DATA Function > USB (B) Function (00=OFF, 01=RTTY Decode, 02=DV Data)
		0133	00 to 04 SET > Connectors > CI-V > USB (B)/DATA Function > DATA Function (00=OFF, 01=RTTY Decode, 02=DV Data, 03= GPS/Weather, 04= CI-V)
		0134	00 or 01 SET > Connectors > CI-V > USB (B)/DATA Function > GPS Out (00=OFF, 01=DATA→USB (B))
		0135	00 or 01 SET > Connectors > CI-V > USB (B)/DATA Function > DV Data/GPS Out Baud Rate (00=4800bps, 01=9600bps)
		0136	00 to 03 SET > Connectors > CI-V > USB (B)/DATA Function > RTTY Decode Baud Rate (00=4800bps, 01=9600bps, 02=19200bps, 03=38400bps)
		0137	00 or 01 SET > Network > DHCP (Valid after Restart) (00=OFF, 01=ON)
		0138	0000000000 ~ 0255025502 550254 SET > Network > IP Address (Valid after Restart) (0000000000000001=0.0.0.1 to 0255025502 550254=255.255.255.254) (Valid when the DHCP (Valid after Restart) is set to OFF.)

Remote control

◇ Command table (Continued)

Cmd.	Sub cmd.	Data	Description
1A*	05	0139 *1 0000000000 000001 ~ 0255025502 550254	SET > Network > DHCP (Valid after Restart) Read the IP address set by the DHCP server (0000000000000001=0.0.0.1 to 0255025502 550254=255.255.255.254) (When the DHCP setting (Valid after Restart) is set to OFF, the manually set IP address (static IP address) is returned.)
		0140	01 ~ 30 SET > Network > Subnet Mask (Valid after Restart) (01=128.0.0.0 (1 bit) to 30=255.255.255.252 (30 bit)) (Valid when the DHCP (Valid after Restart) setting is set to OFF.)
		0141	0000000000 000001 ~ 0255025502 550254, FF SET > Network > Default Gateway (Valid after Restart) (0000000000000001=0.0.0.1 to 0255025502 550254=255.255.255.254, FF=Blank) (Valid when the DHCP (Valid after Restart) setting is set to OFF.)
		0142	0000000000 000001 ~ 0255025502 550254, FF SET > Network > Primary DNS Server (Valid after Restart) (0000000000000001=0.0.0.1 to 0255025502 550254=255.255.255.254, FF=Blank) (Valid when the DHCP (Valid after Restart) setting is set to OFF.)
		0143	0000000000 000001 ~ 0255025502 550254, FF SET > Network > 2nd DNS Server (Valid after Restart) (0000000000000001=0.0.0.1 to 0255025502 550254=255.255.255.254, FF=Blank) (Valid when the DHCP (Valid after Restart) setting is set to OFF.)
		0144	See p. 15 SET > Network > Network Name (Up to 15 characters)
		0145	00 or 01 SET > Network > Network Control (Valid after Restart) (00=OFF, 01=ON)
		0146	00 or 01 SET > Network > Power OFF Setting (for Remote Control) (00=Shutdown only, 01=Standby/Shutdown)
		0147	000001 ~ 065535 SET > Network > Control Port (UDP) (Valid after Restart) (000001=1 to 065535=65535)
		0148	000001 ~ 065535 SET > Network > Serial Port (UDP) (Valid after Restart) (000001=1 to 065535=65535)
		0149	000001 ~ 065535 SET > Network > Audio Port (UDP) (Valid after Restart) (000001=1 to 065535=65535)
		0150	00 or 01 SET > Network > Internet Access Line (Valid after Restart) (00=FTTH (Fiber To The Home), 01=ADSL/ CATV)
		0151	See p. 15 SET > Network > Network Radio Name (Up to 16 characters)
		0152	0000 ~ 0255 SET > Display > LCD Backlight (0000=0% to 0255=100%)
		0153	00 or 01 SET > Display > Display Type (00=A, 01=B)
		0154	00 or 01 SET > Display > Display Font (00=Basic, 01=Round)
		0155	00 or 01 SET > Display > Meter Peak Hold (Bar) (00=OFF, 01=ON)
		0156	00 or 01 SET > Display > Memory Name (00=OFF, 01=ON)
		0157	00 or 01 SET > Display > MN-Q Popup (MN OFF→ON) (00=OFF, 01=ON)
		0158	00 or 01 SET > Display > BW Popup (PBT) (00=OFF, 01=ON)
		0159	00 or 01 SET > Display > BW Popup (FIL) (00=OFF, 01=ON)
		0160	00 to 03 SET > Display > RX Call Sign Display (00=OFF, 01=Normal, 02=RX Hold, 03=Hold)
		0161	00 or 01 SET > Display > RX Position Indicator (00=OFF, 01=ON)
		0162	00 to 02 SET > Display > RX Position Display (00=OFF, 01=ON (Main/Sub), 02=ON (Main Only))

Cmd.	Sub cmd.	Data	Description
1A*	05	0163	00 to 04 SET > Display > RX Position Display Timer (00=5 sec, 01=10 sec, 02=15 sec, 03=30 sec, 04=Hold)
		0164	00 or 01 SET > Display > Reply Position Display (00=OFF, 01=ON)
		0165	00 to 02 SET > Display > TX Call Sign Display (00=OFF, 01=Your Call Sign, 02=My Call Sign)
		0166	00 or 01 SET > Display > Scroll Speed (00=Slow, 01=Fast)
		0167	00 to 03 SET > Display > Screen Saver (00=OFF, 01=15 min., 02=30 min., 03=60 min.)
		0168	00 or 01 SET > Display > Opening Message (00=OFF, 01=ON)
		0169	00 or 01 SET > Display > Power ON Check (00=OFF, 01=ON)
		0170	00 or 01 SET > Display > Display Unit > Latitude/Longitude (00=ddd°mm.mm', 01=ddd°mm'ss")
		0171	00 or 01 SET > Display > Display Unit > Altitude/Distance (00=m, 01=ft/mi)
		0172	00 to 02 SET > Display > Display Unit > Speed (00=km/h, 01=mph, 02=knots)
		0173	00 or 01 SET > Display > Display Unit > Temperature (00=°C, 01=°F)
		0174	00 to 03 SET > Display > Display Unit > Barometric (00=hPa, 01=mb, 02=mmHg, 03=inHg)
		0175	00 or 01 SET > Display > Display Unit > Rainfall (00=mm, 01=inch)
		0176	00 to 03 SET > Display > Display Unit > Wind Speed (00=m/s, 01=km/h, 02=mph, 03=knots)
		0177	00 or 01 SET > Display > Display Language (00=English, 01=Japanese)
		0178	00 or 01 SET > Display > System Language (00=English, 01=Japanese)
		0179	20000101 ~ 20991231 SET > Time Set > Date/Time > Date (20000101=2000/01/01 to 20991231=2099/12/31)
		0180	0000 ~ 2359 SET > Time Set > Date/Time > Time (0000=00:00 to 2359=23:59)
		0181	00 or 01 SET > Time Set > Date/Time > NTP Function (00=OFF, 01=ON)
		0182	See p. 15 SET > Time Set > Date/Time > NTP Server Address
		0183	00 or 01 SET > Time Set > Date/Time > GPS Time Correct (00=OFF, 01=Auto)
		0184	See p. 16 SET > Time Set > UTC Offset
		0185	00 to 02 SET > SD Card > Import/Export > CSV Format > Separator/Decimal (00=Separator is " ," and Decimal is " . ," 01=Separator is " ; , " and Decimal is " . ," 02=Separator is " ; , " and Decimal is " ; , ")
		0186	00 to 02 SET > SD Card > Import/Export > CSV Format > Date (00=""yyyymm/dd," 01=""mm/dd/yyyy," 02=""dd/mm/yyyy")
		0187	00 or 01 SCOPE > Scope during Tx (CENTER TYPE) (00=OFF, 01=ON)
		0188	00 to 02 SCOPE > Max Hold (00=OFF, 01=10s Hold, 02=ON)
		0189	00 ~ 02 SCOPE > CENTER Type Display (00=Filter center, 01=Carrier point center, 02=Carrier point center (Abs. Freq.))
		0190	00 or 01 SCOPE > Marker Position (Fix Type) (00=Filter center, 01 Carrier point)
		0191	See p. 16 SCOPE > VBW
		0192	00 to 03 SCOPE > Averaging (00=OFF, 01=2, 02=3, 03=4)
		0193	00 or 01 SCOPE > Waveform Type (00=Fill, 01=Fill+Line)
		0194	See p. 16 SCOPE > Waveform Color (Current)
		0195	See p. 16 SCOPE > Waveform Color (Line)
		0196	See p. 16 SCOPE > Waveform Color (Max Hold)
		0197	00 or 01 SCOPE > Waterfall Display (00=OFF, 01=ON)

Remote control

◇ Command table (Continued)

Cmd.	Sub cmd.	Data	Description
1A*	05	0198	00 to 02 SCOPE > Waterfall Speed (00=Slow, 01=Mid, 02=Fast)
		0199	00 to 02 SCOPE > Waterfall Size (Expand Screen) (00=Small, 01=Mid, 02=Large)
		0200	00 to 07 SCOPE > Waterfall Peak Color Level (00=Grid 1 to 07=Grid 8)
		0201	00 or 01 SCOPE > Waterfall Marker Auto-hide (00=OFF, 01=ON)
		0202	See p. 17 SCOPE > Fixed Edges > 144M > No.1:
		0203	See p. 17 SCOPE > Fixed Edges > 144M > No.2:
		0204	See p. 17 SCOPE > Fixed Edges > 144M > No.3:
		0205	See p. 17 SCOPE > Fixed Edges > 430M > No.1:
		0206	See p. 17 SCOPE > Fixed Edges > 430M > No.2:
		0207	See p. 17 SCOPE > Fixed Edges > 430M > No.3:
		0208	See p. 17 SCOPE > Fixed Edges > 1200M > No.1:
		0209	See p. 17 SCOPE > Fixed Edges > 1200M > No.2:
		0210	See p. 17 SCOPE > Fixed Edges > 1200M > No.3:
		0211	00 or 01 AUDIO SCOPE SET > FFT Scope Waveform Type (00=Line, 01=Fill)
		0212	See p. 16 AUDIO SCOPE SET > FFT Scope Waveform Color
		0213	00 or 01 AUDIO SCOPE SET > FFT Scope Waterfall Display (00=OFF, 01=ON)
		0214	See p. 16 AUDIO SCOPE SET > Oscilloscope Waveform Color
		0215	0000 ~ 0255 VOICE TX > TX LEVEL (0000=0%, 0255=100%)
		0216	00 or 01 VOICE TX SET > Auto Monitor (00=OFF, 01=ON)
		0217	01 to 15 VOICE TX SET > Repeat Time (01=1 sec. to 15=15 sec.)
		0218	00 to 04 KEYER 001 > Number Style (00=Normal, 01=190→ANO, 02=190→ANT, 03=90→NO, 04=90→NT)
		0219	01 to 08 KEYER 001 > Count Up Trigger (01=M1 to 08=M8)
		0220	0001 to 9999 KEYER 001 > Present Number (0001=1 to 9999=9999)
		0221	0000 ~ 0255 CW-KEY SET > Side Tone Level (0000=0% to 0255=100%)
		0222	00 or 01 CW-KEY SET > Side Tone Level Limit (00=OFF, 01=ON)
		0223	01 to 60 CW-KEY SET > Keyer Repeat time (01=1 sec. to 60=60 sec.)
		0224	28 to 45 CW-KEY SET > Dot/Dash Ratio (28=1:1:2.8 to 45=1:1:4.5; 0.1 steps)
		0225	00 to 03 CW-KEY SET > Rise Time (00=2 msec., 01=4 msec., 02=6 msec., 03=8 msec.)
		0226	00 or 01 CW-KEY SET > Paddle Polarity (00=Normal, 01=Reverse)
		0227	00 to 02 CW-KEY SET > Key Type (00=Straight, 01=Bug, 02=Paddle)
		0228	00 or 01 CW-KEY SET > MIC Up/Down Keyer (00=OFF, 01=ON)
		0229	00 to 03 RTTY DECODE SET > FFT Scope Averaging (00=OFF, 01=2, 02=3, 03=4)
		0230	See p. 16 RTTY DECODE SET > FFT Scope Waveform Color
		0231	00 or 01 RTTY DECODE SET > Decode USOS (00=OFF, 01=ON)
		0232	00 or 01 RTTY DECODE SET > Decode New Line Code (00=CR, LF, CR+LF, 01=CR+LF)
		0233	00 or 01 RTTY DECODE SET > TX USOS (00=OFF, 01=ON)
		0234	00 or 01 RTTY DECODE SET > Displayed Characters during Tx (Satellite) (00=Displayed Characters during RX, 01=Displayed Characters during TX)
		0235	See p. 16 RTTY DECODE SET > Font Color (Receive)
		0236	See p. 16 RTTY DECODE SET > Font Color (Transmit)
		0237	00 or 01 RTTY DECODE LOG > Decode Log (00=OFF, 01=ON)
		0238	00 or 01 RTTY DECODE LOG > Log Set > File Type (00=Text, 01=HTML)

Cmd.	Sub cmd.	Data	Description
1A*	05	0239	00 or 01 RTTY DECODE SET > Log Set > Time Stamp (00=OFF, 01=ON)
		0240	00 or 01 RTTY DECODE SET > Log Set > Time Stamp (Time) (00=Local, 01=UTC)
		0241	00 or 01 RTTY DECODE SET > Log Set > Time Stamp (Frequency) (00=OFF, 01=ON)
		0242	00 or 01 QSO RECORDER > Recorder Set > TX REC Audio (00=Direct, 01=Monitor)
		0243	00 or 01 QSO RECORDER > Recorder Set > RX REC Condition (00=Always, 01=Squelch Auto)
		0244	00 or 01 QSO RECORDER > Recorder Set > File Split (00=OFF, 01=ON)
		0245	00 or 01 QSO RECORDER > Recorder Set > REC Operation (00=MAIN/SUB Separate, 01=MAIN/SUB Link)
		0246	00 or 01 QSO RECORDER > Recorder Set > PTT Auto REC (00=OFF, 01=ON)
		0247	00 to 03 QSO RECORDER > Recorder Set > PRE-REC for PTT Auto REC (00=OFF, 01=5 sec., 02=10 sec., 03=15 sec.)
		0248	00 to 03 QSO RECORDER > Player Set > Skip Time (00=3 sec., 01=5 sec., 02=10 sec., 03=30 sec.)
		0249	00 or 01 SCAN SET > SCAN Speed (00=Slow, 01=Fast)
		0250	00 or 01 SCAN SET > SCAN Resume (00=OFF, 01=ON)
		0251	00 to 10 SCAN SET > Pause Timer (00=2 sec. to 09=20 sec.; 2 sec. steps, 10=HOLD)
		0252	00 to 06 SCAN SET > Resume Timer (00=0 sec. to 05=5 sec., 06=HOLD)
		0253	00 to 04 SCAN SET > Temporary Skip Timer (00=5 min., 01=10 min., 02=15 min., 03=While Scanning, 04=While Powered ON)
		0254	00 or 01 SCAN SET > MAIN DIAL Operation (SCAN) (00=OFF, 01=Up/Down)
		0255	00 to 02 GPS > GPS Set > GPS Select (00=OFF, 01=External GPS, 02=Manual)
		0256	00 or 01 GPS > GPS Set > GPS Receiver Baud Rate (00=4800bps, 01=9600bps)
		0257	See p. 17 GPS > GPS Set > Manual Position
		0258	00 to 02 GPS > GPS TX Mode (00=OFF, 01=D-PRS, 02=NMEA)
		0259	See p. 17 GPS > GPS TX Mode > D-PRS > Unproto Address (Up to 56 characters)
		0260	00 to 03 GPS > GPS TX Mode > D-PRS > TX Format (00=Position, 01=Object, 02=Item, 03=Weather)
		0261	00 to 04 GPS > GPS TX Mode > D-PRS > TX Format > Position > Symbol (00=No.1, 01=No.2, 02=No.3, 03=No.4)
		0262	See p. 17 GPS > GPS TX Mode > D-PRS > TX Format > Position > the GPS-A Symbol No.1 setting (2 characters)
		0263	See p. 17 GPS > GPS TX Mode > D-PRS > TX Format > Position > the GPS-A Symbol No.2 setting (2 characters)
		0264	See p. 17 GPS > GPS TX Mode > D-PRS > TX Format > Position > the GPS-A Symbol No.3 setting (2 characters)
		0265	See p. 17 GPS > GPS TX Mode > D-PRS > TX Format > Position > the GPS-A Symbol No.4 setting (2 characters)
		0266	00 to 42 GPS > GPS TX Mode > D-PRS > TX Format > Position > SSID (00=---, 01=(-), 02=-1 to 16=-15, 17=A to 42=Z)
		0267	00 to 03 GPS > GPS TX Mode > D-PRS > TX Format > Position > Comment (00=1 to 03=4)

Remote control

◇ Command table (Continued)

Cmd.	Sub cmd.	Data	Description
1A*	05	0268	See p. 17 GPS > GPS TX Mode > D-PRS > TX Format > Position > Comment 1 (Up to 43 characters)
		0269	See p. 17 GPS > GPS TX Mode > D-PRS > TX Format > Position > Comment 2 (Up to 43 characters)
		0270	See p. 17 GPS > GPS TX Mode > D-PRS > TX Format > Position > Comment 3 (Up to 43 characters)
		0271	See p. 17 GPS > GPS TX Mode > D-PRS > TX Format > Position > Comment 4 (Up to 43 characters)
		0272	00 to 02 GPS > GPS TX Mode > D-PRS > TX Format > Position > Time Stamp (00=OFF, 01=DHM, 02=HMS)
		0273	00 or 01 GPS > GPS TX Mode > D-PRS > TX Format > Position > Altitude (00=OFF, 01=ON)
		0274	00 to 02 GPS > GPS TX Mode > D-PRS > TX Format > Position > Data Extension (00=OFF, 01=Course/Speed, 02=Power/Height/Gain/Directivity)
		0275	00 to 09 GPS > GPS TX Mode > D-PRS > TX Format > Position > Power (00=0W, 01=1W, 02=4W, 03=9W, 04=16W, 05=25W, 06=36W, 07=49W, 08=64W, 09=81W)
		0276	00 to 09 GPS > GPS TX Mode > D-PRS > TX Format > Position > Height (00=3 m (10 ft), 01=6 m (20 ft), 02=12 m (40 ft), 03=24 m (80 ft), 04=49 m (160 ft), 05=98 m (320 ft), 06=195 m (640 ft), 07=390 m (1280 ft), 08=780 m (2560 ft), 09=1561 m (5120 ft))
		0277	00 to 09 GPS > GPS TX Mode > D-PRS > TX Format > Position > Gain (00=0 dB to 09=9 dB)
		0278	00 to 08 GPS > GPS TX Mode > D-PRS > TX Format > Position > Directivity (00=Omni, 01=45°NE, 02=90°E, 03=135°SE, 04=180°S, 05=225°SW, 06=270°W, 07=315°NW, 08=360°N)
		0279	See p. 17 GPS > GPS TX Mode > D-PRS > TX Format > Object > Object Name (Up to 9 characters)
		0280	00 or 01 GPS > GPS TX Mode > D-PRS > TX Format > Object > Data Type (00=Live Object, 01=Kill Object)
		0281	See p. 17 GPS > GPS TX Mode > D-PRS > TX Format > Object > Symbol (2 characters)
		0282	See p. 17 GPS > GPS TX Mode > D-PRS > TX Format > Object > Comment (Up to 43 characters)
		0283	See p. 17 GPS > GPS TX Mode > D-PRS > TX Format > Object > Position
		0284	00 to 02 GPS > GPS TX Mode > D-PRS > TX Format > Object > Data Extension (00=OFF, 01=Course/Speed, 02=Power/Height/Gain/Directivity)
		0285	000 to 360 GPS > GPS TX Mode > D-PRS > TX Format > Object > Course (0° to 360°; 1 degree steps)
		0286	00 to 1850 GPS > GPS TX Mode > D-PRS > TX Format > Object > Speed (0 km/h to 1850 km/h)
		0287	00 to 09 GPS > GPS TX Mode > D-PRS > TX Format > Object > Power (00=0W, 01=1W, 02=4W, 03=9W, 04=16W, 05=25W, 06=36W, 07=49W, 08=64W, 09=81W)
		0288	00 to 09 GPS > GPS TX Mode > D-PRS > TX Format > Object > Height (00=3 m (10 ft), 01=6 m (20 ft), 02=12 m (40 ft), 03=24 m (80 ft), 04=49 m (160 ft), 05=98 m (320 ft), 06=195 m (640 ft), 07=390 m (1280 ft), 08=780 m (2560 ft), 09=1561 m (5120 ft))
		0289	00 to 09 GPS > GPS TX Mode > D-PRS > TX Format > Object > Gain (00=0 dB to 09=9 dB)
		0290	00 to 08 GPS > GPS TX Mode > D-PRS > TX Format > Object > Directivity (00=Omni, 01=45°NE, 02=90°E, 03=135°SE, 04=180°S, 05=225°SW, 06=270°W, 07=315°NW, 08=360°N)

Cmd.	Sub cmd.	Data	Description
1A*	05	0291	00 to 42 GPS > GPS TX Mode > D-PRS > TX Format > Object > SSID (00=---, 01=(-), 02=-1 to 16=-15, 17=-A to 42=-Z)
		0292	00 or 01 GPS > GPS TX Mode > D-PRS > TX Format > Object > Time Stamp (00=DHM, 01=HMS)
		0293	See p. 17 GPS > GPS TX Mode > D-PRS > TX Format > Item > Item Name (Up to 9 characters)
		0294	00 or 01 GPS > GPS TX Mode > D-PRS > TX Format > Item > Data Type (00=Live Item, 01=Killed Item)
		0295	See p. 17 GPS > GPS TX Mode > D-PRS > TX Format > Item > Symbol (2 characters)
		0296	See p. 17 GPS > GPS TX Mode > D-PRS > TX Format > Item > Comment (Up to 43 characters)
		0297	See p. 17 GPS > GPS TX Mode > D-PRS > TX Format > Item > Position
		0298	00 to 02 GPS > GPS TX Mode > D-PRS > TX Format > Item > Data Extension (00=OFF, 01=Course/Speed, 02=Power/Height/Gain/Directivity)
		0299	000 to 360 GPS > GPS TX Mode > D-PRS > TX Format > Item > Course (0° to 360°; 1 degree steps)
		0300	00 to 1850 GPS > GPS TX Mode > D-PRS > TX Format > Item > Speed (0 km/h to 1850 km/h)
		0301	00 to 09 GPS > GPS TX Mode > D-PRS > TX Format > Item > Power (00=0W, 01=1W, 02=4W, 03=9W, 04=16W, 05=25W, 06=36W, 07=49W, 08=64W, 09=81W)
		0302	00 to 09 GPS > GPS TX Mode > D-PRS > TX Format > Item > Height (00=3 m (10 ft), 01=6 m (20 ft), 02=12 m (40 ft), 03=24 m (80 ft), 04=49 m (160 ft), 05=98 m (320 ft), 06=195 m (640 ft), 07=390 m (1280 ft), 08=780 m (2560 ft), 09=1561 m (5120 ft))
		0303	00 to 09 GPS > GPS TX Mode > D-PRS > TX Format > Item > Gain (00=0 dB to 09=9 dB)
		0304	00 to 08 GPS > GPS TX Mode > D-PRS > TX Format > Item > Directivity (00=Omni, 01=45°NE, 02=90°E, 03=135°SE, 04=180°S, 05=225°SW, 06=270°W, 07=315°NW, 08=360°N)
		0305	00 to 42 GPS > GPS TX Mode > D-PRS > TX Format > Item > SSID (00=---, 01=(-), 02=-1 to 16=-15, 17=-A to 42=-Z)
		0306	See p. 17 GPS > GPS TX Mode > D-PRS > TX Format > Weather > Symbol (2 characters)
		0307	00 to 42 GPS > GPS TX Mode > D-PRS > TX Format > Weather > SSID (00=---, 01=(-), 02=-1 to 16=-15, 17=-A to 42=-Z)
		0308	See p. 17 GPS > GPS TX Mode > D-PRS > TX Format > Weather > Comment (Up to 43 characters)
		0309	00 to 02 GPS > GPS TX Mode > D-PRS > TX Format > Weather > Time Stamp (00=OFF, 01=DHM, 02=HMS)
		0310 *6	00 or 01 GPS > GPS TX Mode > NMEA > GPS Sentence (RMC) (00=OFF, 01=ON)
		0311 *6	00 or 01 GPS > GPS TX Mode > NMEA > GPS Sentence (CGA) (00=OFF, 01=ON)
		0312 *6	00 or 01 GPS > GPS TX Mode > NMEA > GPS Sentence (GLL) (00=OFF, 01=ON)
		0313 *6	00 or 01 GPS > GPS TX Mode > NMEA > GPS Sentence (GSA) (00=OFF, 01=ON)
		0314 *6	00 or 01 GPS > GPS TX Mode > NMEA > GPS Sentence (VTG) (00=OFF, 01=ON)
		0315 *6	00 or 01 GPS > GPS TX Mode > NMEA > GPS Sentence (GSV) (00=OFF, 01=ON)

Remote control

◇ Command table (Continued)

Cmd.	Sub cmd.	Data	Description	
1A*	05	0316	See p. 17 GPS > GPS TX Mode > NMEA > GPS Message (Up to 20 characters)	
		0317	See p. 17 GPS > GPS Alarm > Alarm Area (Group)	
		0318	00 to 03 GPS > GPS Alarm > Alarm Area (RX/Memory) (00=Limited, 01=Extended, 02=Both)	
		0319	00 to 08 GPS > GPS Auto TX 00=OFF, 01**=5 sec., 02=10 sec., 03=30 sec., 04=1 min., 05=3 min., 06=5 min., 07=10 min., 08=30 min. **When 4 kinds of GPS sentences are selected, you cannot select "01."	
		0320	00 to 03 DTMF SET > DTMF Speed (00=100ms, 01=200ms, 02=300ms, 03=500 ms)	
		0321	0000 to 0255 Set the NB LEVEL (144 MHz) (0000=0% to 0255=100%)	
		0322	00 to 09 Set the NB DEPTH (144 MHz) (00=1 to 09=10)	
		0323	0000 to 0255 Set the NB WIDTH (144 MHz) (0000=1 to 0255=100)	
		0324	0000 to 0255 Set the NB LEVEL (430 MHz) (0000=0% to 0255=100%)	
		0325	00 to 09 Set the NB DEPTH (430 MHz) (00=1 to 09=10)	
		0326	0000 to 0255 Set the NB WIDTH (430 MHz) (0000=1 to 0255=100)	
		0327	0000 to 0255 Set the NB LEVEL (1200 MHz) (0000=0% to 0255=100%)	
		0328	00 to 09 Set the NB DEPTH (1200 MHz) (00=1 to 09=10)	
		0329	0000 to 0255 Set the NB WIDTH (1200 MHz) (0000=1 to 0255=100)	
		0330	00 to 20 Set the VOX DELAY (00=0.0 sec. to 20=2.0 sec.; 0.1 sec steps)	
		0331	00 to 03 Set the VOX voice delay (00=OFF, 01=Short, 02=Mid, 03=Long)	
		0332	00 or 01 Set the TX PWR LIMIT (144M) function (00=OFF, 01=ON)	
		0333	0000 to 0255 Set the TX PWR LIMIT (144M) (0000=1 to 0255=100)	
		0334	00 or 01 Set the TX PWR LIMIT (430M) function (00=OFF, 01=ON)	
		0335	0000 to 0255 Set the TX PWR LIMIT (430M) (0000=1 to 0255=100)	
		0336	00 or 01 Set the TX PWR LIMIT (1200M) function (00=OFF, 01=ON)	
		0337	0000 to 0255 Set the TX PWR LIMIT (1200M) (0000=1 to 0255=100)	
		0338	00 or 01 Set the Received Call sign Display ("Name" or "Call Sign") (00=Call Sign, 01=Name)	
		0339	00 to 02 Set the Compass Direction (00=Heading Up, 01=North Up, 02=South Up)	
			06	See p. 17 DATA mode with filter set
			07	See p. 18 Set the Satellite memory contents
			08	00 or 01 NTP server access (00=Terminate, 01=Initiate)
	09*1	00 to 02 Read NTP server access result (00=Accessing, or have not accessed after Power ON, 01=Succeeded, 02=Failed)		
	0A*1	00 or 01 Read the OVf indicator status (00=OFF, 01=ON)		
1B*	00	See p. 19 Send/read the Repeater tone frequency		
	01	See p. 19 Send/read the TSQL tone frequency		
	02	See p. 19 Send/read the DTCS code and polarity		
	07	See p. 19 Send/read the CSQ code (DV mode)		
1C	00*	00 or 01 Send/read the transceiver's status (00=RX, 01=TX)		
	02*	00 or 01 Send/read the Transmit frequency monitor (XFC) (00=OFF, 01=ON)		
	03*1	See p. 13 Read the transmit frequency		

Cmd.	Sub cmd.	Data	Description
1E	00*1		Read number of available TX frequency band
	01*1	See p. 13	Read TX band edge frequencies
	02*1		Read number of user-set TX frequency band
1F*	03*	See p. 13	Set the user-set TX band edge frequencies
	00	See p. 19	SET > My Station > My Call Sign (DV)
	01	See p. 19	SET > Display > TX Call Sign Display
	02	See p. 19	SET > My Station > TX Message (DV)
20	00	00* 00 or 01*7	Send/read the Auto DV RX Call signs output (00=OFF, 01=ON)
		01	See p. 20 Output DV RX Call signs for transceive
		02*1	See p. 20 Read Auto DV RX Call signs
	01	00* 00 or 01*7	Send/read the Auto DV RX message output (00=OFF, 01=ON)
		01	See p. 20 Output DV RX message for transceive
		02*1	See p. 20 Read Auto DV RX message
	02	00* 00 or 01*7	Send/read the Auto DV RX status output (00=OFF, 01=ON)
		01	See p. 20 Output DV RX status for transceive
		02*1	See p. 20 Read Auto DV RX status
	03	00* 00 or 01*7	Send/read the Auto DV RX GPS/D-PRS data output (00=OFF, 01=ON)
		0100	See p. 21 Output DV RX GPS/D-PRS Position for transceive
		0101	See p. 21 Output DV RX D-PRS Object status for transceive
		0102	See p. 21 Output DV RX D-PRS Item status for transceive
		0103	See p. 21 Output DV RX D-PRS Weather status for transceive
		0200*1	See p. 21 Read Auto DV RX GPS/D-PRS Position status
		0201*1	See p. 21 Read Auto DV RX D-PRS Object status
	0202*1	See p. 21 Read Auto DV RX D-PRS Item status	
	0203*1	See p. 21 Read Auto DV RX D-PRS Weather status	
	04	00* 00 or 01*7	Send/read Auto DV RX GPS/D-PRS message output (00=OFF, 01=ON)
		01	See p. 22 Output DV RX D-PRS message for transceive
02*1		See p. 22 Read Auto DV RX D-PRS message status	
21*	00	See p. 23 RIT frequency	
	01	00 or 01 RIT setting (00=OFF, 01=ON)	
22	00	See p. 23 Set the DV TX data (Up to 30 byte)	
	01	00* 00 or 01	Set the Auto DV RX data output
		01	See p. 23 Set the DV RX data for transceive (Up to 30 byte)
	02*	00 or 01	SET > DV/DD Set > DV Data TX (00=PTT, 01=Auto)
	03*	00 or 01	SET > DV/DD Set > DV Fast Data > Fast Data (00=OFF, 01=ON)
04*	00 or 01	SET > DV/DD Set > DV Fast Data > GPS Data Speed (00=Slow, 01=Fast)	
	05*	00 to 10	SET > DV/DD Set > DV Fast Data > TX Delay (PTT) (00=OFF, 01=1 sec. to 10=10 sec.)
23	00*1	See p. 23 Read the position status	
	01*	00, 02, 03	GPS > GPS Set > GPS Select (00=OFF, 02=External GPS, 03=Manual)
	02*	See p. 17 GPS > GPS Set > Manual Position	
24	00	00* 00 or 01	Send/read TX output power setting (00=OFF, 01=ON)
		01	00 or 01 Set the TX output power for transceive (00=OFF, 01=ON)
25*		See p. 23 Set the selected or unselected VFO frequency (Only MAIN band)	
26*		See p. 23 Set the selected or unselected VFO's operating mode and filter (Only MAIN band)	

Remote control

◇ Command table (Continued)

Cmd.	Sub cmd.	Data	Description
27	00	See p. 24	Read the Scope waveform data (Only when "Scope ON/OFF status" (Command: 27 10) and "Scope data output" (Command: 27 11) are set to "ON," outputs the waveform data to the controller.)
	10*	00 or 01	Send/read the Scope ON/OFF status (00=OFF, 01=ON)
	11*.*8	00 or 01	Send/read the Scope wave data output (00=OFF, 01=ON)
	12*	00 or 01	Send/read the Main or Sub scope setting (00=Main, 01=Sub)
	14*	See p. 24	Send/read the Scope Center mode or Fixed mode setting
	15*	See p. 24	Send/read the Span setting in the Center mode Scope
	16*	See p. 24	Send/read the Edge number setting in the Fixed mode Scope
	17*	See p. 24	Send/read the Scope hold function ON/OFF status
	19*	See p. 24	Send/read the Scope Reference level setting
	1A*	See p. 25	Send/read the Sweep speed setting
	1B*	00 or 01	SCOPE > Scope during Tx (CENTER TYPE) (00=OFF, 01=ON)
	1C*	00 to 02	SCOPE > CENTER Type Display (00=Filter center, 01=Carrier point center, 02=Carrier point center (Abs. Freq.))
	1D*	See p. 16	Send/read the Scope VBW setting
	1E*	See p. 25	Send/read the Scope Fixed edge frequencies
28	00	00 to 08	Voice TX Memory (00=Stop, 01=T1 to 08=T8)

*(Asterisk) Send/read data

*1 Read only data

*2 Send only data

*3 In the CW mode, if the [TRANSMIT] or an external TX switch is ON, or the Break-in function is ON, a message will be transmitted as CW code when you send it from your PC.

*4 When sending the power ON command (18 01), you need to repeatedly send "FE" before the standard format. The following is the approximate number of needed repetitions.

- 115200 bps: 119 "FE"s
- 57600 bps: 59 "FE"s
- 38400 bps: 40 "FE"s
- 19200 bps: 20 "FE"s
- 9600 bps: 9 "FE"s
- 4800 bps: 5 "FE"s

Example: When using 4800 bps

Preamble		9700's address		Controller's address		Command		Sub command		Postamble					
F	E	F	E	F	E	A	2	E	0	1	8	0	1	F	D

×5

*5 To insert a counter, first clear the other channel's counter.

*6 Set at least 1 GPS sentence to ON.

Up to 4 GPS sentences can be set to ON at the same time.

*7 Output setting is automatically set to OFF after turning OFF the transceiver.

*8 When you use the [USB] port, select "Unlink from [REMOTE]" in the "CI-V USB port" item, and select "115200" in the "CI-V Baud Rate" item.

MENU » **SET > Connectors > CI-V**

You can use the [LAN] port, regardless of those settings. You cannot use the [REMOTE] terminal, regardless of those settings.

Remote control

◆ Command formats

• Operating frequency

Command: 00, 03, 05, 1C 03

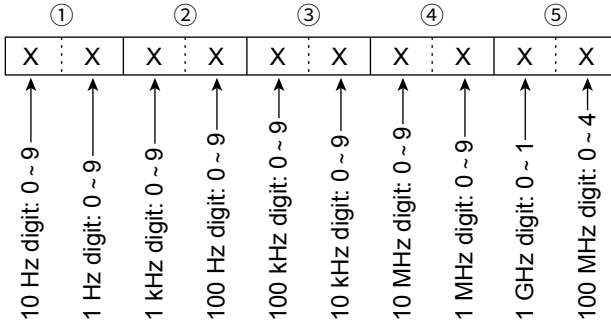

• Duplex Offset frequency setting

Command: 0C, 0D

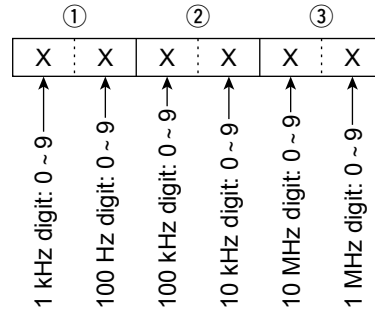

① Only the 1200 MHz band can input 10 MHz digits.

• Operating mode

Command: 01, 04, 06

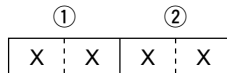

① Operating mode		② Filter setting
00: LSB	05 : FM	01: FIL1
01: USB	07 : CW-R	02: FIL2
02: AM	08 : RTTY-R	03: FIL3
03: CW	17 : DV	—
04: RTTY	22 : DD*	—

* 22 Command (DD) can be selected when setting the 1200 MHz band to other than the satellite mode.

① Filter setting, (②) can be skipped with command 01 and 06. In that case, "FIL1" is selected with command 01 and the default filter setting of the operating mode is automatically selected with command 06.

• Codes for CW message contents

Command: 17 Up to 30 characters

To send CW messages, use the following character codes.

Character	ASCII code	Character	ASCII code
0 ~ 9	30 ~ 39	'	27
A ~ Z	41 ~ 5A	(28
a ~ z	61 ~ 7A)	29
/	2F	=	3D
?	3F	+	2B
.	2E	"	22
-	2D	@	40
,	2C	Space	20
:	3A		

① "FF" stops sending CW messages.

① "^" is used to transmit a string of characters with no inter-character space.

• Band edge frequency settings

Command: 02*, 1E 01, 1E 03

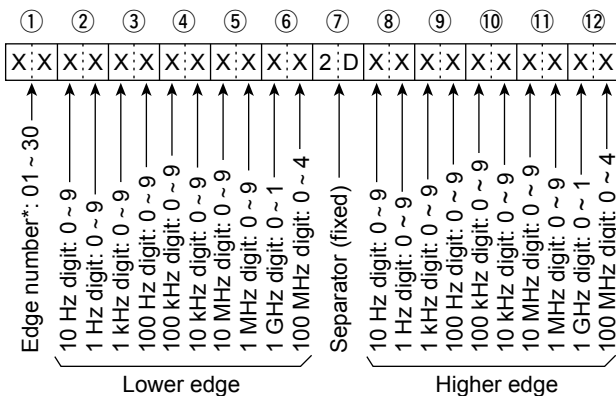

* When obtaining the edge number (by command "02"), the edge number (①) is not returned.

Remote control

◇ Command formats (Continued)

• Memory content

Command: 1A 00

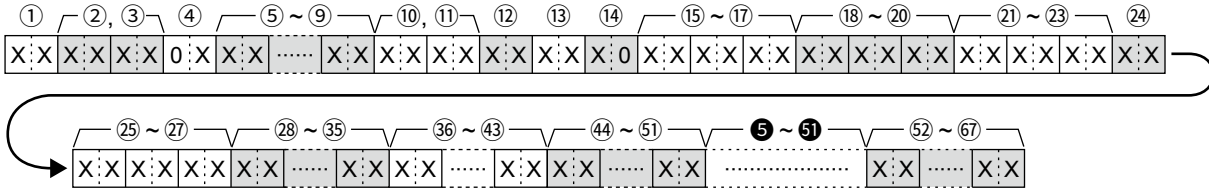

① Frequency band setting

01: 144 MHz frequency band
02: 430 MHz frequency band
03: 1.2 GHz frequency band

②, ③ Memory channel number

0001 ~ 0099: Memory channel 1 to 99
0100, 0101: Program Scan Edge channel 1A, 1B
0102, 0103: Program Scan Edge channel 2A, 2B
0104, 0105: Program Scan Edge channel 3A, 3B
0106, 0107: Call channel C1, C2

④ Select memory setting

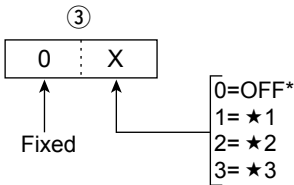

* For program scan edge channel, call channel, set to "0."

⑤ ~ ⑨ Operating frequency setting

See "Operating frequency." (p. 13)

⑩, ⑪ Operating mode setting

See "Operating mode." (p. 13)

⑫ Data mode setting

1 byte data (XX)
00: Data mode OFF
01: Data mode ON

⑬ Duplex and Tone settings

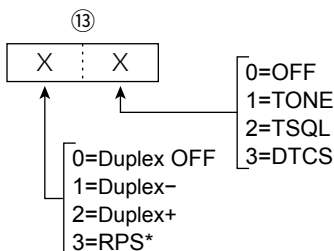

* RPS can be set when DD mode is selected, and DUP (+, -) can be set when other than DD mode is selected.

⑭ Digital squelch setting

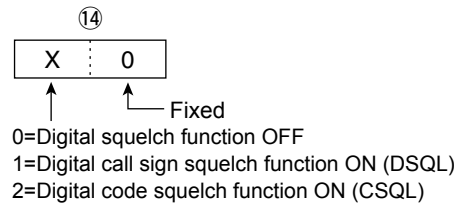

⑮ ~ ⑰ Repeater tone frequency setting

⑱ ~ ⑳ Tone squelch frequency setting
See "Repeater tone/tone squelch frequency setting." (p. 19)

㉑ ~ ㉓ DTCS code setting

See "DTCS code and polarity setting." (p. 19)

㉔ DV Digital code squelch setting

See "DV Digital code squelch setting." (p. 19)

㉕ ~ ㉗ Duplex offset frequency setting

See "Duplex Offset frequency setting." (p. 13)

㉘ ~ ㉙ UR (Destination) call sign setting (8 characters; fixed)

㉚ ~ ㉛ R1 (Access repeater) call sign setting (8 characters; fixed)

㉜ ~ ㉝ R2 (Gateway/Link repeater) call sign setting (8 characters; fixed)

See "DV TX call signs setting." (p. 19)

㉞ ~ ㉟ Memory name setting (16 characters; fixed)

See "Codes for character entries." (p. 15)

To clear the memory channel contents on 1A 00:

②, ③ :Memory channel (0001~0099)

④ : "FF," ⑤ ~ :None

NOTE:

- The same data as ⑤ ~ ⑤① are stored in ⑤ ~ ⑤①.
- When the Split function is ON, the data of ⑤ ~ ⑤① is used for transmit.
- Even if the Split function is OFF, enter the data into ⑤ ~ ⑤① to match your transceiver. We recommend that you set the same data as ⑤ ~ ⑤①.

Remote control

◇ Command formats (Continued)

• Codes for character entries

Command: 1A 00,

1A 05 0144, 0151, 0182, 0259,
0279, 0281, 0293, 0316

1A 05 0262 ~ 1A 05 0265,

1A 05 0268 ~ 1A 05 0271

- Character codes— Letters and Numbers

Character	ASCII code	Character	ASCII code
A ~ Z	41 ~ 5A	a ~ z	61 ~ 7A
0 ~ 9	30 ~ 39		

- Character codes— Symbols

Character	ASCII code	Character	ASCII code
!	21	#	23
\$	24	%	25
&	26	\	5C
?	3F	"	22
'	27	`	60
^	5E	+	2B
-	2D	*	2A
/	2F	.	2E
,	2C	:	3A
;	3B	=	3D
<	3C	>	3E
(28)	29
[5B]	5D
{	7B	}	7D
	7C	_	5F
~	7E	@	40

Command	Set item/selectable characters
1A 00	Memory name All characters are usable.
1A 05 0144	SET > Network > Network Name (up to 15 characters)
0151	SET > Network > Network Radio Name (up to 16 characters)
0182	SET > Time Set > Date/Time > NTP Server Address

• Band stacking register

Command: 1A 01

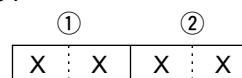

NOTE:

When sending the contents, the codes, such as operating frequency and operating mode*, should be added after the frequency band code and the register code, as shown below.

* See ⑤ to ⑤① on 'Memory content setting.' (p. 14)

① Frequency band codes

Code	Freq. band	Frequency range (unit: MHz)
01	VHF	144.000000 ~ 148.000000
02	UHF	430.000000 ~ 450.000000
03	1.2GHz	1240.000000 ~ 1300.000000

② Register codes

Code	Registered number
01	1 (Display on left side)
02	2 (Display in center)
03	3 (Display on Right side)

To read the contents, the register code should be added after the frequency band code, as shown below.

Example: When reading the frequency displayed in the center of the display in the VHF band, use code "0202."

• Memory keyer character entries

Command: 1A 02

- Character codes

Character	ASCII code	Description
0 ~ 9	30 ~ 39	Numbers
A ~ Z	41 ~ 5A	Letters
space	20	Word space
/	2F	Symbol
?	3F	Symbol
,	2C	Symbol
.	2E	Symbol
@	40	Symbol
^	5E	Example: to send $\overline{\text{BT}}$, enter ^4254
*	2A	Inserts contest number (can be used for 1 channel only)

Remote control

◇ Command formats (Continued)

• Memory key content

Command: 1A 02

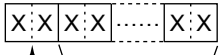

② ~ ⑦: Text data

①: Channel data

01=M1 05=M5
02=M2 06=M6
03=M3 07=M7
04=M4 08=M8

• IF filter width settings

Command: 1A 03

Mode	Data	Steps
SSB/CW/RTTY	0 to 9	50 ~ 500 Hz (50 Hz)
SSB/CW	10 to 40	600 Hz ~ 3.6 kHz (100 Hz)
RTTY	10 to 31	600 ~ 2.7 kHz (100 Hz)
AM	0 to 49	200 Hz ~ 10.0 kHz (200 Hz)

• AGC time constant settings

Command: 1A 04

Data	AGC time constant (sec.)	
	SSB/CW/RTTY	AM
0	OFF	OFF
1	0.1	0.3
2	0.2	0.5
3	0.3	0.8
4	0.5	1.2
5	0.8	1.6
6	1.2	2.0
7	1.6	2.5
8	2.0	3.0
9	2.5	4.0
10	3.0	5.0
11	4.0	6.0
12	5.0	7.0
13	6.0	8.0

• RX HPF/LPF setting for each operating mode

Command: 1A 05 0001, 0004, 0007,
0010, 0013, 0014

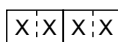

HPF (Lower edge) LPF (Upper edge)

00=Through

05 ~ 24=500~2400 Hz

01 ~ 20=100 ~ 2000 Hz

25=Through

*The value of the HPF should be smaller than the LPF.

• SSB/SSB-DATA transmission passband width settings

Command: 1A 05 0017 ~ 1A 05 0020

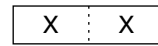

Lower edge Higher edge

0= 100 Hz 0= 2500 Hz

1= 200 Hz 1= 2700 Hz

2= 300 Hz 2= 2800 Hz

3= 500 Hz 3= 2900 Hz

Lower edge

Higher edge

• Split offset frequency setting

Command: 1A 05 0044

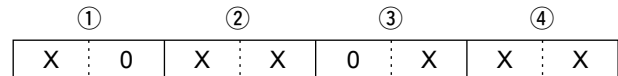

①
1 kHz digit: 0 ~ 9

②
100 Hz digit: 0 (fixed)

③
100 kHz digit: 0 ~ 9

④
10 kHz digit: 0 ~ 9

⑤
10 MHz digit: 0 (fixed)

⑥
1 MHz digit: 0 ~ 9

Direction:
00=+ direction
01=- direction

• UTC Offset setting

Command: 1A 05 0184

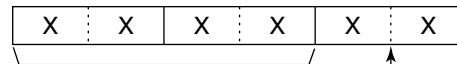

Offset time
0000 ~ 1400

Shift direction
00=+ (plus)
01=- (minus)

• Scope VBW (Video Band Width) settings

Command: 1A 05 0191, 27 1D

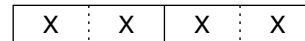

00=MAIN

00=Narrow

01=SUB

01=Wide

• Color settings

Command: 1A 05 0194, 0195, 0196, 0212, 0214,
0230, 0235, 0236

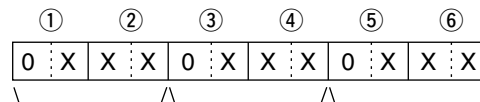

R (Red)

G (Green)

B (Blue)

0000 ~ 0255

0000 ~ 0255

0000 ~ 0255

Remote control

◇ Command formats (Continued)

• Bandscope edge frequency settings

Command: 1A 05 0202 ~ 1A 05 0210

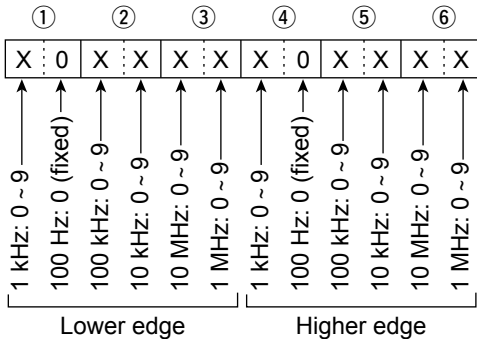

• Manually entered position data

Command: 1A 05 0257, 0283, 0297, 23 02

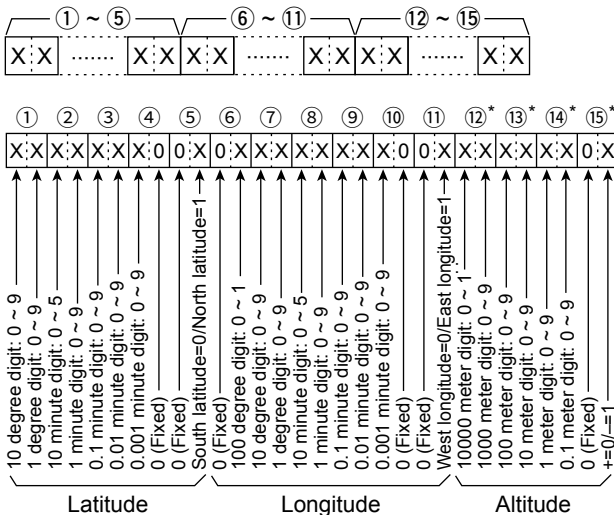

- ① ~ ⑤: Latitude (dd°mm.mmm format)
- ⑥ ~ ⑪: Longitude (ddd°mm.mmm format)
- ⑫ ~ ⑮: Altitude (0.1 meter steps)

* When reading the contents with no altitude, sends ⑫, ⑬, ⑭ and ⑮ as "FF."

* When sending the contents with no altitude, set ⑫, ⑬, ⑭ and ⑮ to "FF."

• Unproto Address setting

Command: 1A 05 0259

Set an unproto address of up to 56 characters.
See "Codes for character entries." (p. 15)

• Entering Object name or Item name

Command: 1A 05 0279, 0293

Enter an Object or Item name of up to 9 characters.
See "Codes for character entries." (p. 15)

• D-PRS Symbol setting

Command: 1A 05 0262 ~ 1A 05 0265,
1A 05 0281, 0295, 0306

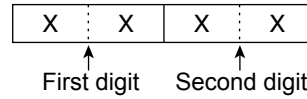

/, \, 0 to 9, A to Z can be used for the first digit character.

See "Codes for character entries" for the second digit character. (p.15)

• D-PRS Comment setting

Command: 1A 05 0268 ~ 1A 05 0271
1A 05 0282, 0296, 0308

Set a comment of up to 43 characters.

See "Codes for character entries." (p. 15)

• GPS message setting

Command: 1A 05 0316

Set a GPS message of up to 20 characters.

See "Codes for character entries." (p. 15)

• Alarm area (Group) setting

Command: 1A 05 0317

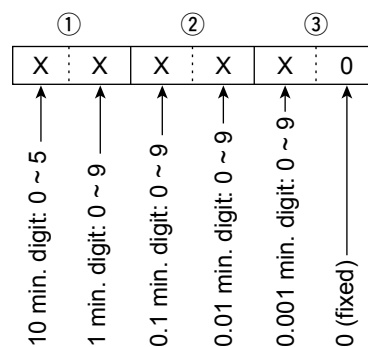

• Data mode with filter width settings

Command: 1A 06

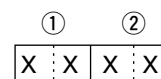

00=Data mode OFF*

01=Data mode ON

01=FIL1

02=FIL2

03=FIL3

*When 00 is set, also set 00 to ②.

Remote control

◇ Command formats (Continued)

• Satellite memory content setting

Command: 1A 07

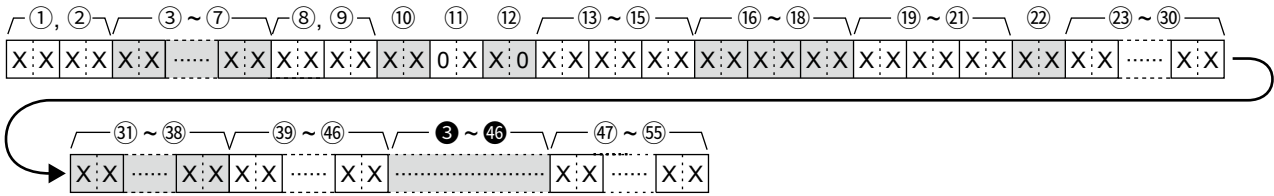

①, ② Satellite memory channel number
0001 ~ 0099: Satellite memory channel 1 to 99

③ ~ ⑦ Operating frequency setting
See "Operating frequency." (p. 13)

⑧, ⑨ Operating mode setting
See "Operating mode." (p. 13)

⑩ Data mode setting
1 byte data (XX)
00: Data mode OFF
01: Data mode ON

⑪ Tone settings

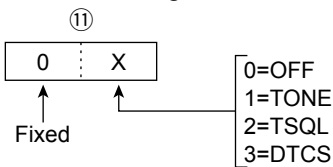

⑫ Digital squelch setting

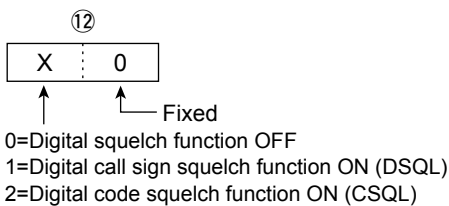

⑬ ~ ⑮ Repeater tone frequency setting
⑯ ~ ⑰ Tone squelch frequency setting
See "Repeater tone/tone squelch frequency setting." (p. 19)

⑱ ~ ⑲ DTCS code setting
See "DTCS code and polarity setting." (p. 19)

⑳ DV Digital code squelch setting
See "DV Digital code squelch setting." (p. 19)

㉑ ~ ㉓ UR (Destination) call sign setting
(8 characters; fixed)

㉔ ~ ㉗ R1 (Access repeater) call sign setting
(8 characters; fixed)

㉘ ~ ㉜ R2 (Gateway/Link repeater) call sign setting
(8 characters; fixed)
See "DV TX call signs setting." (p. 19)

㉝ ~ ㉟ Memory name setting
(16 characters; fixed)
See "Codes for character entries." (p. 15)

NOTE:

- The same data as ③ ~ ④⑥ are stored in ③ ~ ④⑥.
- ③ ~ ④⑥ is used for the uplink frequency (transmit).
- ③ ~ ④⑥ is used for the downlink frequency (receive).

Remote control

◇ Command formats (Continued)

• Repeater tone/tone squelch frequency settings

Command: 1B 00, 1B 01

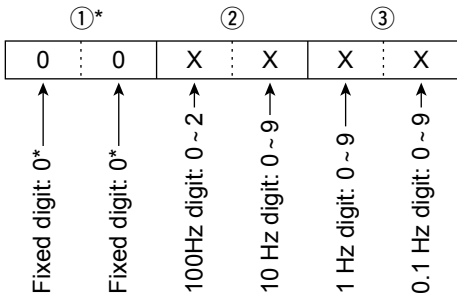

*Not necessary when setting a frequency.

• DTCS code and polarity setting

Command: 1B 02

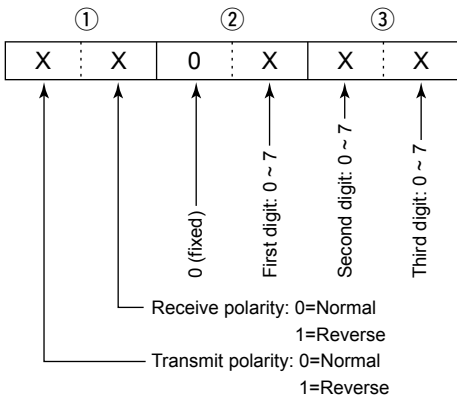

• DV Digital code squelch setting

Command: 1B 07

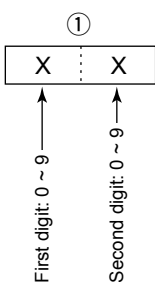

• DV MY call sign setting

Command: 1F 00

Set your own call sign and note of up to 12 characters.
See "Character's code of the call sign."

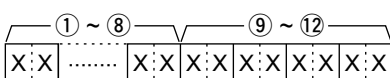

① ~ ⑧: Your own call sign setting (8 characters)

⑨ ~ ⑫: Note setting (4 characters)

• DV TX call signs setting (24 characters)

Command: 1F 01

Set "UR," "R1" and "R2" call signs of 8 characters (fixed).

See "Character's code of the call sign."

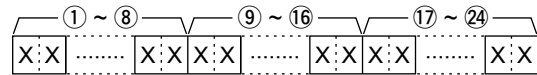

① ~ ⑧: UR (Destination) call sign setting (8 characters)

⑨ ~ ⑯: R1 (Access/Area repeater) call sign setting (8 characters)

⑰ ~ ⑳: R2 (Link/Gateway repeater) call sign setting (8 characters)

Character's code of the call sign

Character	ASCII code
0 ~ 9	30 ~ 39
A ~ Z	41 ~ 5A
(Space)	20
/	2F

• DV TX message setting

Command: 1F 02

Set the transmit message of up to 20 characters.

"FF" stops sending or reading messages.

Character	ASCII code	Character	ASCII code
A ~ Z	41 ~ 5A	a ~ z	61 ~ 7A
0 ~ 9	30 ~ 39	Space	20
!	21	#	23
\$	24	%	25
&	26	\	5C
?	3F	"	22
'	27	`	60
^	5E	+	2B
-	2D	*	2A
/	2F	.	2E
,	2C	:	3A
;	3B	=	3D
<	3C	>	3E
(28)	29
[5B]	5D
{	7B	}	7D
!	7C	_	5F
-	7E	@	40

Remote control

◇ Command formats (Continued)

• DV RX call sign data

Command: 20 0001, 20 0002

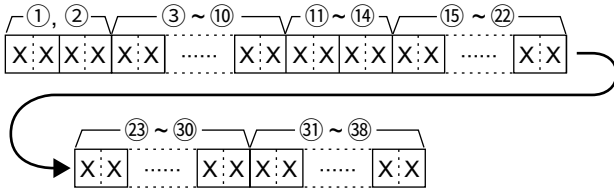

① Header flag data (First byte)

Data	Description
bit7 (0: Fixed)	—
bit6 (0: Fixed)	—
bit5 (0: Fixed)	—
bit4 0/1	0=Voice, 1=Data
bit3 0/1	0=Direct, 1=Through repeater
bit2 0/1	0=No Break-in, 1=Break-in
bit1 0/1	0=Data, 1=Control
bit0 0/1	0=Normal, 1=EMR

② Header flag data (Second byte)

Data			Description
bit2	bit1	bit0	
1	1	1	Repeater control
1	1	0	Send auto acknowledge
1	0	1	(Not used)
1	0	0	Request to re-transmit
0	1	1	Send acknowledge
0	1	0	Receive no reply
0	0	1	Repeater disabled
0	0	0	NULL

- ③ ~ ⑩: Call sign of the caller station (8 characters, fixed)
- ⑪ ~ ⑭: Note of the caller station (4 characters, fixed)
- ⑮ ~ ⑳: Call sign of the called station (8 characters, fixed)
- ㉓ ~ ㉟: Call sign of the access/area repeater (R1) (8 characters, fixed)
- ㉑ ~ ㉗: Call sign of the link/gateway repeater (R2) (8 characters, fixed)
- ①FF: When no call sign is received since the transceiver power was turned ON.

• DV RX message

Command: 20 0101, 20 0102

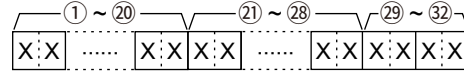

- ① ~ ⑳: Message (20 characters)
- ㉑ ~ ㉘: Call sign of the caller station (8 characters)
- ㉙ ~ ㉜: Note of the caller station (4 characters)
- See "Codes for character entries." (p. 15)
- ①FF: When no call sign is received since the transceiver power was turned ON.

Example: When a Gateway call is received

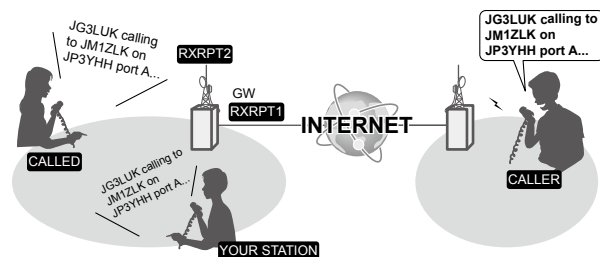

- CALLER: Caller's call sign
- CALLED: Called station call sign
- RXRPT1: Call sign of the repeater that was accessed by the caller station
 - ① If it was a call through a gateway and the internet, this item displays the gateway call sign of the repeater you received the call from.
- RXRPT2: Call sign of the repeater you received the call from

• DV RX Status setting

Command: 20 0201, 20 0202

Data	Function	Description
bit7 0	(Fixed)	—
bit6 0/1	Receiving a voice call	While receiving a digital voice signal, select "1." (Regardless of DSQL and CSQL setting)
bit5 0/1	Last call finisher	When the last call was finished by you, select "1."
bit4 0/1	Receiving a signal	When the audio tone can be heard, select "1."
bit3 0/1	Receiving a BK call	While receiving a BK call, select "1."
bit2 0/1	Receiving a EMR call	While receiving a EMR call, select "1."
bit1 0/1	Receiving a signal other than DV	When "DV" and "FM" are blinking, select "1."
bit0 0/1	Packet loss status	While displaying packet loss, "1" is returned.

Remote control

◇ Command formats (Continued)

• GPS/D-PRS data

Command: 20 03 0100, 0200, 0101, 0201, 0102, 0202, 0103, 0203

Data number and description

Data number	Description
00	D-PRS— Position
01	D-PRS— Object
02	D-PRS— Item
03	D-PRS— Weather

Position

Command: 20 03 0100, 0200

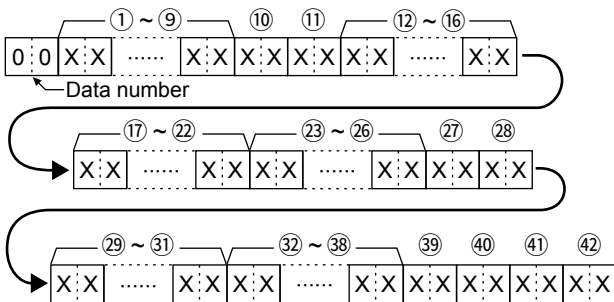

- ① ~ ⑨: Call sign/SSID
(9 ASCII characters (A ~ Z, 0 ~ 9, /, -, space))
- ⑩, ⑪: Symbol
(2 ASCII characters (00h ~ EFh))
- ⑫ ~ ⑰: Latitude (dd°mm.mmm format)
- ⑱ ~ ⑳: Longitude (ddd°mm.mmm format)
- ㉑ ~ ㉒: Altitude (0.1 meter steps)
- ㉓, ㉔: Course (1 degree steps)
- ㉕ ~ ㉖: Speed (0.1 km/h steps)
- ㉗ ~ ㉘: Date (UTC: yyyyymmddHHMMSS)
(y: Year, m: Month, d: Day, H: Hour, M: Minute, S: Second)
- ㉙: Power (see the table below)
- ㉚: Height (see the table below)
- ㉛: Gain (see the table below)
- ㉜: Directivity (see the table below)

Data	Power (W)	Height (m/ft)	Gain (dB)	Directivity (deg)
0	0	3/10	0	Omni-direction
1	1	6/20	1	45° NE
2	4	12/40	2	90° E
3	9	24/80	3	135° SE
4	16	49/160	4	180° S
5	25	98/320	5	225° SW
6	36	195/640	6	270° W
7	49	390/1280	7	315° NW
8	64	780/2560	8	360° N
9	81	1561/5120	9	—

- ① The item, that is not contained the received data, is filled with "FF."
- ① FF: No signal has been received since the power was turned ON.

Object

Command: 20 03 0101, 0201

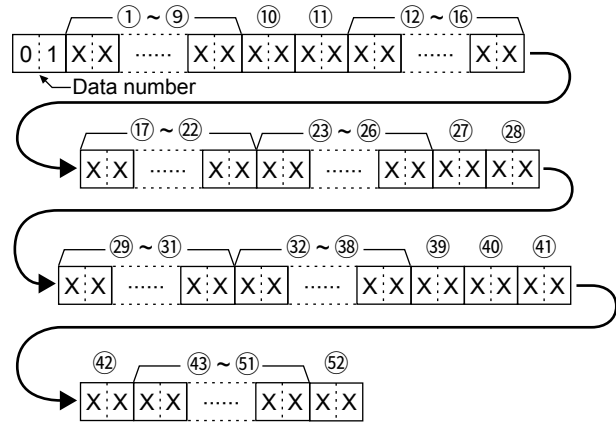

- ① ~ ⑨: Call sign/SSID
(9 ASCII characters (A ~ Z, 0 ~ 9, /, -, space))
- ⑩, ⑪: Symbol
(2 ASCII characters (00h ~ EFh))
- ⑫ ~ ⑰: Latitude (dd°mm.mmm format)
- ⑱ ~ ⑳: Longitude (ddd°mm.mmm format)
- ㉑ ~ ㉒: Altitude (0.1 meter steps)
- ㉓, ㉔: Course (1 degree steps)
- ㉕ ~ ㉖: Speed (0.1 km/h steps)
- ㉗ ~ ㉘: Date (UTC: yyyyymmddHHMMSS)
(y: Year, m: Month, d: Day, H: Hour, M: Minute, S: Second)
- ㉙: Power (see the table below)
- ㉚: Height (see the table below)
- ㉛: Gain (see the table below)
- ㉜: Directivity (see the table below)

Data	Power (W)	Height (m/ft)	Gain (dB)	Directivity (deg)
0	0	3/10	0	Omni-direction
1	1	6/20	1	45° NE
2	4	12/40	2	90° E
3	9	24/80	3	135° SE
4	16	49/160	4	180° S
5	25	98/320	5	225° SW
6	36	195/640	6	270° W
7	49	390/1280	7	315° NW
8	64	780/2560	8	360° N
9	81	1561/5120	9	—

- ④③ ~ ④⑤: Name
(9 ASCII characters (00h ~ EFh))
- ④⑥: Type (1= Live, 0= Killed)

- ① The item, that is not contained the received data, is filled with "FF."
- ① FF: No signal has been received since the power was turned ON.

Remote control

◇ Command formats

• GPS/D-PRS data (Continued)

Item

Command: 20 03 0102, 0202

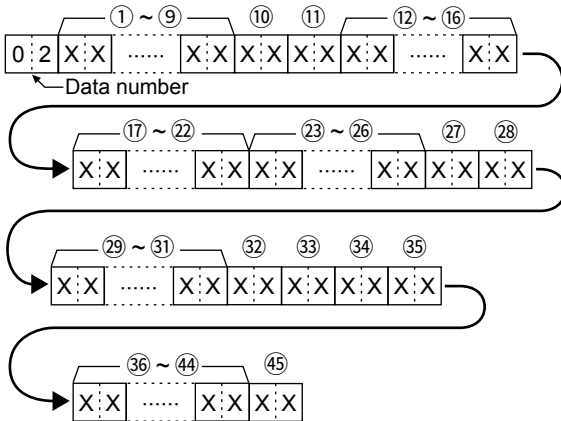

- ① ~ ⑨: Call sign/SSID
(9 ASCII characters (A ~ Z, 0 ~ 9, /, -, space))
- ⑩, ⑪: Symbol
(2 ASCII characters (00h ~ EFh))
- ⑫ ~ ⑯: Latitude (dd°mm.mmm format)
- ⑰ ~ ⑳: Longitude (ddd°mm.mmm format)
- ㉓ ~ ㉖: Altitude (0.1 meter steps)
- ㉗, ㉘: Course (1 degree steps)
- ㉙ ~ ㉛: Speed (0.1 km/h steps)
- ㉜: Power (see the table below)
- ㉝: Height (see the table below)
- ㉞: Gain (see the table below)
- ㉟: Directivity (see the table below)

Data	Power (W)	Height (m/ft)	Gain (dB)	Directivity (deg)
0	0	3/10	0	Omni-direction
1	1	6/20	1	45° NE
2	4	12/40	2	90° E
3	9	24/80	3	135° SE
4	16	49/160	4	180° S
5	25	98/320	5	225° SW
6	36	195/640	6	270° W
7	49	390/1280	7	315° NW
8	64	780/2560	8	360° N
9	81	1561/5120	9	—

- ㉞ ~ ㉟: Name
(9 ASCII characters (00h ~ EFh))
- ㊱: Type (1= Live, 0= Killed)

- ① The item, that is not contained the received data, is filled with "FF."
- ①FF: No signal has been received since the power was turned ON.

Weather

Command: 20 03 0103, 0203

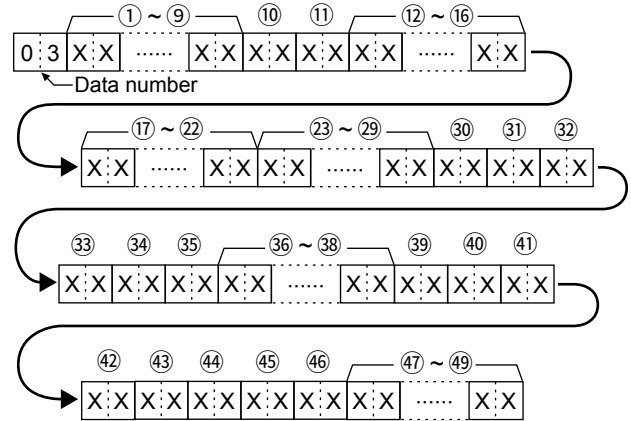

- ① ~ ⑨: Call sign/SSID
(9 ASCII characters (A ~ Z, 0 ~ 9, /, -, space))
- ⑩, ⑪: Symbol
(2 ASCII characters (00h ~ EFh))
- ⑫ ~ ⑯: Latitude (dd°mm.mmm format)
- ⑰ ~ ⑳: Longitude (ddd°mm.mmm format)
- ㉓ ~ ㉙: Date (UTC: yyyyymmddHHMMSS)
(y: Year, m: Month, d: Day, H: Hour, M: Minute, S: Second)
- ㉚, ㉛: Wind direction (1 degree steps)
- ㉜, ㉝: Wind speed (0.1 m/s steps)
- ㉞, ㉟: Gust speed (0.1 m/s steps)
- ㊰ ~ ㊱: Temperature (0.1°C steps)
- ㊲ : Temperature (0= + degree, 1= - degree)
- ㊳, ㊴: Rainfall (0.1 mm steps)
- ㊵, ㊶: Rainfall (24 hours) (0.1 mm steps)
- ㊷, ㊸: Rainfall (Midnight) (0.1 mm steps)
- ㊹, ㊺: Humidity (1% steps)
- ㊻ ~ ㊽: Barometric pressure (0.1 hPa steps)

- ① The item, that is not contained the received data, is filled with "FF."
- ①FF: No signal has been received since the power was turned ON

• GPS/D-PRS message

Command: 20 0401, 0402

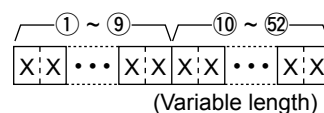

- ① ~ ⑨: Call sign/SSID
(9 ASCII characters (A ~ Z, 0 ~ 9, /, -, space))
- ⑩ ~ ⑵: Message
(Up to 43 ASCII characters (00h ~ EFh))
- ①FF: When no call sign is received since the transceiver power was turned ON.

Remote control

◇ Command formats (Continued)

• RIT frequency settings

Command: 21 00

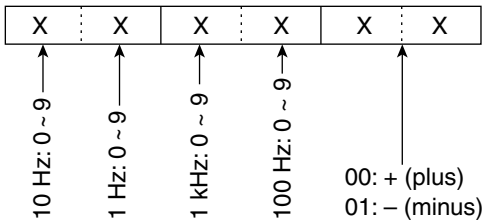

• DV TX data

Command: 22 00

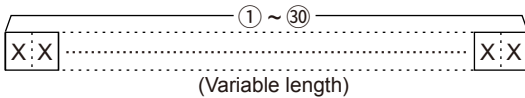

- ① ~ ③⑩: Tx, data (Up to 30 Byte)
 ("FA" to "FF" are entered after converted to "FF 0A" to "FF 0F" automatically. Up to 60 Byte data can be entered in this case.)

• DV RX data (transceiver)

Command: 22 0101

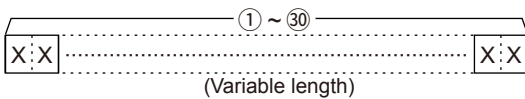

- ① ~ ③⑩: Rx, data (Up to 30 Byte)
 ("FA" to "FF" are entered after converted to "FF 0A" to "FF 0F" automatically. Up to 60 Byte data can be entered in this case.)

• MY position data

Command: 23 00

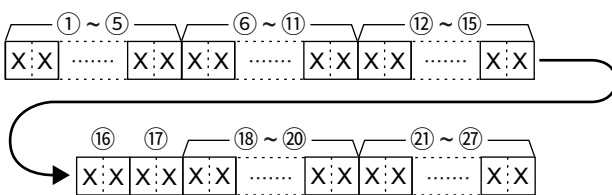

- ① ~ ⑤: Latitude (dd°mm.mmm format)
 ⑥ ~ ⑪: Longitude (ddd°mm.mmm format)
 ⑫ ~ ⑮: Altitude (0.1 meter steps)
 ⑰, ⑱: Course (1 degree steps)
 ⑲ ~ ⑳: Speed (0.1 km/h steps)
 ㉑ ~ ㉒: Date (UTC: yyyyymmddHHMMSS)
 (y: Year, m: Month, d: Day, H: Hour, M: Minute, S: Second)

• Selected or unselected VFO frequency settings (Only MAIN band)

Command: 25

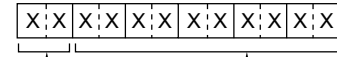

*00=Selected VFO
 01=Unselected VFO
 Operating frequency See "Operating frequency." (p. 13)

- ① You cannot set the SUB band frequency.
 *00/01 can be set in the VFO mode. (In the satellite mode, "FA" (NG) is returned.)
 In the memory channel mode, call channel mode, or DR function, the transceiver returns "FA" (NG) because these cannot be set to 01.

- When VFO A is selected
 00=frequency of VFO A changes
 01=frequency of VFO B changes
 • When VFO B is selected
 00=frequency of VFO B changes
 01=frequency of VFO A changes

• Selected or unselected VFO's operating mode and filter settings (Only MAIN band)

Command: 26

① You cannot set the SUB band operating mode and filter settings. Both data and filter settings can be skipped. In that case, "DATA OFF" and the default filter setting of the operating mode is automatically selected.

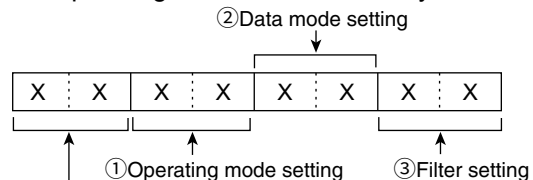

*00=Selected VFO
 01=Unselected VFO

- *00/01 can be set in the VFO mode. (In the satellite mode, "FA" (NG) is returned.)
 In the memory channel mode, call channel mode, or DR function, the transceiver returns "FA" (NG) because these cannot be set to 01.

- When VFO A is selected
 00=operating mode of VFO A changes
 01=operating mode of VFO A changes of VFO B changes
 • When VFO B is selected
 00=operating mode of VFO A changes of VFO B changes
 01=operating mode of VFO A changes of VFO A changes

① Operating mode setting	② Data mode setting	③ Filter setting
00: LSB	05: FM	00: Data mode OFF*2
01: USB	07: CW-R	01: Data mode ON
02: AM	08: RTTY-R	02: FIL2
03: CW	17: DV	03: FIL3
04: RTTY	22: DD*1	—

*1 22 Command (DD) can be selected when setting the 1200 MHz band to other than the satellite mode.

*2 When 00 is set, also set 00 to ③.

Remote control

◇ Command formats (Continued)

• Scope waveform data

Command: 27 00

Outputs the waveform data to the controller.

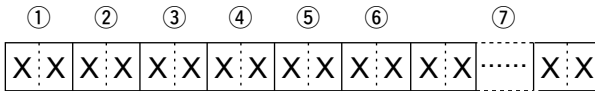

- ① Main or Sub scope data
 - 00=Main scope, 01=Sub scope
- ② Order of division data (Current): 01~11
- ③ Division number (Maximum): 01(LAN), 11(USB)

When data is sent to the controller through the LAN port, all data is sent together. However, when the data is sent through the USB port, the data is divided by 11 and sent in sequential order.

The 1st data sends only the wave information (① ~ ⑥) without the waveform data (⑦).
The 2nd or later data sends the minimum wave information (① ~ ③) with waveform data (⑦).

- ④ Center or Fixed mode data
 - 00 = Center mode scope,
 - 01 = Fixed mode scope

- ⑤ Waveform information

The waveform information is different between the Center mode and the Fixed mode.

 - In the Center mode: Center frequency and span are sent

See page 13 for Operating frequency data, and the Scope span settings to the right.

- In the Fixed mode: Lower edge and higher edge frequencies are sent
- See page 25 for Scope Fixed edge frequency settings ③ ~ ⑫.

- ⑥ Out of range information
 - 00 = In range, 01 = Out of range

If the scope data is out of range, the waveform data (⑦) is omitted.

- ⑦ Waveform data

The transceiver outputs the drawn waveform data. The data range or data length of the waveform data is judged by the controller. (The data range is basically the same as the display size of the scope on the controller.)

Data range	0 ~ 160
Data length	475

• Center/Fixed mode settings

Command: 27 14

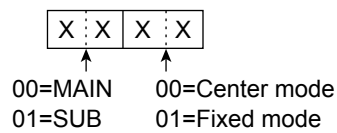

• Scope span settings

Command: 27 15

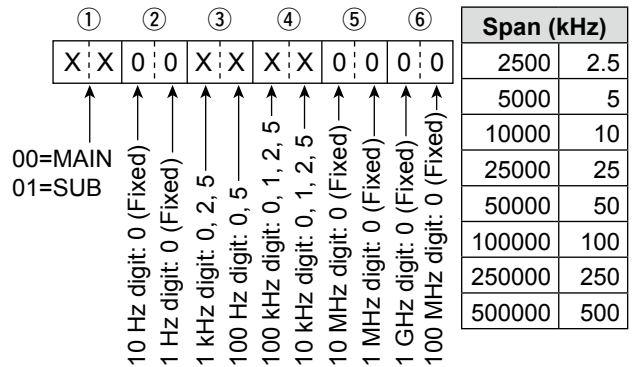

• Scope Edge number settings

Command: 27 16

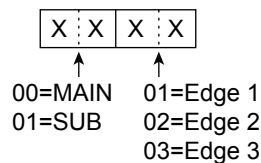

• Scope Hold settings

Command: 27 17

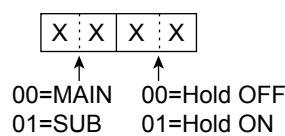

• Scope Reference level settings

Command: 27 19

Common settings for the Main and Sub scopes.

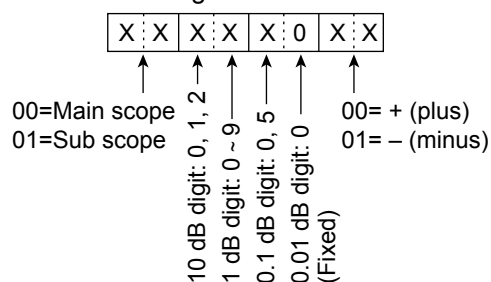

①Adjustable range: -20.0 dB ~ +20.0 dB in 0.5 dB steps.

Count on us!

