

LEIXEN 雷讯

Professional Two-Way Radio

VV-898

无线车载台
MOBILE TRANSCEIVER



用户手册

User Manual

Notice

Please use the transceiver in compliance with local regulations.

A Note To Users

Thank you for purchasing the **LEIXEN** VV-898 Mobile transceiver. We trust this transceiver will give you convenient and reliable communication for many years.

For the best experience, we advise that you read this manual completely before using your new transceiver.

Contents

Security Information	1
Accessories & Options	2
Supplied Accessories	2
Optional Accessories	2
Installation	3
Connect Power	3
Keeping the Transceiver Cool	3
Install with Bracket	4
Connect Accessories	4
Getting Acquainted	6
DTMF Microphone Panel	8
LCD Display	10
Front Panel Description	12
Basic Operation	13
Power on/off	13
Turn Volume	13
Select Channel	13
Transmitting and receiving	14
Function Menu Operation	15
Auto Power Off(APO): Menu 01	16
APRO (APRO): Menu 02	16
Busy Channel Lock (BC Lock): Menu 03	16

Key Beep (Beep): Menu 04.....	17
Channel Save (CHASave): Menu 05.....	17
DTMF Function (DTMF): Menu 06	18
Dual Watch (DW): Menu 07	23
Decode Type and Decode Code (Menus 08 and 09)	23
Encode Type and Encode Code (Menus 10 and 11)	25
FM Radio Function(FM): Menu 12.....	26
FM DualWatch (FM DW): Menu 13.....	27
FM Scan(FM Scan)): Menu 14.....	27
FM SQL (FM SQL): Menu 15	28
Font size (Choose (Font): Menu 16	28
Key Lock Function (Keylock): Menu 17	28
Keypad Function(Keypad): Menu 18.....	29
Backlight (Lamp): Menu 19	29
Setting Channel Names: (Name): Menus 20 /21/22	30
Set Opening Display (OpenDIS): Menu 23	31
Custom Keys Set (P1-P3、 M Key): Menus 24-29	32
High/Low Power Set (Power): Menu 30	33
PTT ID (PTT ID): Menu 31	33

ROGER(ROGER): Menu 32.....	35
REVERSE (REVERSE): Menu 33	35
Offset Frequency (RPT SET/RPT TYPE): Menus 34 and 35	35
Save Battery (SaveBat): Menu 36	37
Scan (SCAN): Menus 37, 38, and 39	37
Squelch Level (SQL): Menu 40	39
Step (Step): Menu 41.....	39
Tail Elimination (Tail): Menu 42.....	40
Talk Around (Talk): Menu 43.....	40
Time out timer(TOT): Menu 44	40
TX Stop (TXStop): Menu 45.....	41
VOX (VOX): Menus 46-49.....	41
Wide and Narrow Bandwidth Set (WidNar): Menu 50.....	42
User-defined Keys Menu	42
OFF	43
FM (FM)	43
Band change (Bandchange)	43
Time of system (Time)	43
Monitor Momentary (MONI)	44
Monitor Lock (MOLO)	44
SQ OFF Momentary (SQM)	44

Mute (MUTE)	45
Scan (SCAN)	45
High/Low Power (LOW)	45
Emergency (EMG)	45
V/M Mode Switch (V/M)	45
DTMF Function (DTMF)	46
Call (Call)	46
Transmit 1750Hz (1750Hz)	46
A/B Mode Switch (A/B)	46
Talk Around (Talk)	46
Reverse Frequency (Reverse)	46
Reset Menu.....	47
All Reset.....	47
Function Reset.....	47
Programming Operation.....	48
Lease Function	48
Wireless Change Frequency	49
RX Inhibit/RXTX Inhibit.....	51
Setting Transmission Limits Per Minute	52
Maintenance	53
Base Knowledge.....	53
Cleaning and Maintenance	53
Specification.....	55

Security Information

To use this transceiver safely and efficiently, please read the following safety information.

- ∞ Refer service to qualified technicians only.
- ∞ Turn off the transceiver while refueling or while parked in a gasoline service station.
- ∞ Please turn off the transceiver where flammable gases or fumes may be present.
- ∞ Do not place the transceiver where it might block airbag deployment.
- ∞ Do not expose the transceiver to long periods of direct sunlight or extreme heat.
- ∞ Do not transmit for long periods, especially at high power. Doing so may damage the transceiver or cause the transceiver to overheat.
- ∞ Do not use the transceiver with a damaged antenna or feedline. Doing so may damage the transmitter.
- ∞ When using this transceiver, Please make sure the antenna is connected. Transmitting without an antenna may damage the final amplifier in the transmitter.
- ∞ Please keep at least 2in (5cm) away from the antenna while transmitting.

-
- ☞ Turn off the power immediately if the transceiver emits peculiar odors or smoke and contact the nearest authorized dealer for service.

Accessories & Options

Welcome to your new VV-898 transceiver. Please unpack it carefully and ensure that the below accessories are included. If you find any missing or damaged components, please contact your dealer immediately.

Supplied Accessories

Item	Qty
Mobile transceiver	1
DC Power Cable	1
Bracket	1
Bracket Screw (Installed in sides of transceiver)	2
User Manual	1

Optional Accessories

USB Programming Cable	DC/AC Adaptor
DTMF Keypad Microphone	No Keypad Microphone
Antenna Mount	Antenna

Installation

Connect Power

This transceiver should be connected to a 13.8V DC power supply. It can not be connected directly to an AC outlet. Connect the transceiver to a regulated power supply with the supplied power cable. Do not replace the DC power cable with a thinner wire. The supplied cable is rated to meet the power requirements of the transceiver.

Connect the DC power cable to a DC power supply or battery. Connect the red wire to the positive terminal and the black wire to the negative terminal. Then, plug the power connector into the DC power outlet of the transceiver.

Note: Make sure to turn off the DC power supply and transceiver before connecting.

The DC power supply can only be connected to an AC power outlet after all connections are completed.

Keeping the Transceiver Cool

As with all modern electronics, it is very important that the transceiver not be allowed to overheat. The VV-898 has been designed to take advantage of natural air flow to keep it cool. Thus, to help in providing enough space for natural air flow, it is very

important that you install the transceiver using the supplied mounting bracket. If the transceiver is installed without providing for adequate air flow, the transceiver may overheat. If adequate air flow is not available, the transceiver will be damaged from overheating. Do not place books or other equipment directly on the transceiver. Allow 4In (10cm) of clearance between the rear of the transceiver and any other objects.

Install with Bracket

An adjustable angle bracket is supplied with the transceiver. Please attach the bracket to your desired installation location. Remove the two mounting screws from the sides of the transceiver and reinstall them through the holes in the bracket.

Note: Do not install the transceiver where it might interfere with the deployment of airbags.

Do not place the transceiver in the front windshield. The heat of the sun may damage the transceiver.

Connect Accessories

Hand Microphone: The Hand microphone connection jack is located on the left side of the front panel of the transceiver.

Earphone: The Earphone connection jack is located in the right of the rear panel of the transceiver. The

internal speaker is muted when an earphone or external speaker is connected to this jack

Antenna: The SO-239 mount connection is on the left of the rear panel of the transceiver. The antenna system is composed of an antenna, feedline, and ground network components. Carefully consider your antenna system installation for best results with this transceiver. For instance, be sure the antenna you will use matches your desired operating frequencies. Selecting an appropriate antenna is beyond the scope of this manual. Do not transmit without first connecting an antenna. Doing so may damage the transceiver.

Getting Acquainted

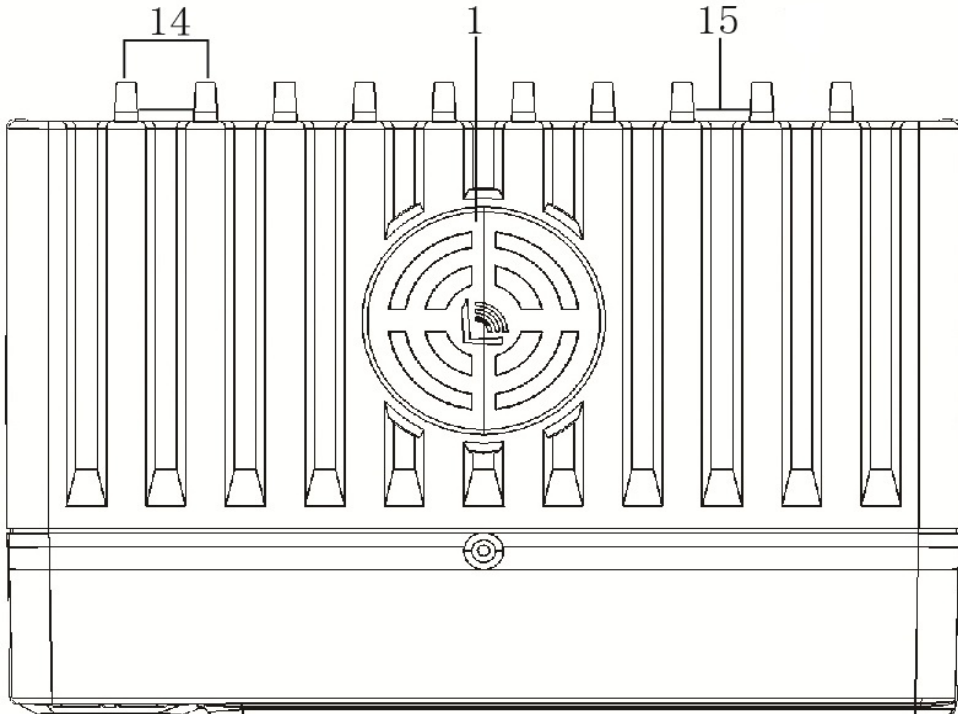

VV-898 Upper Panel

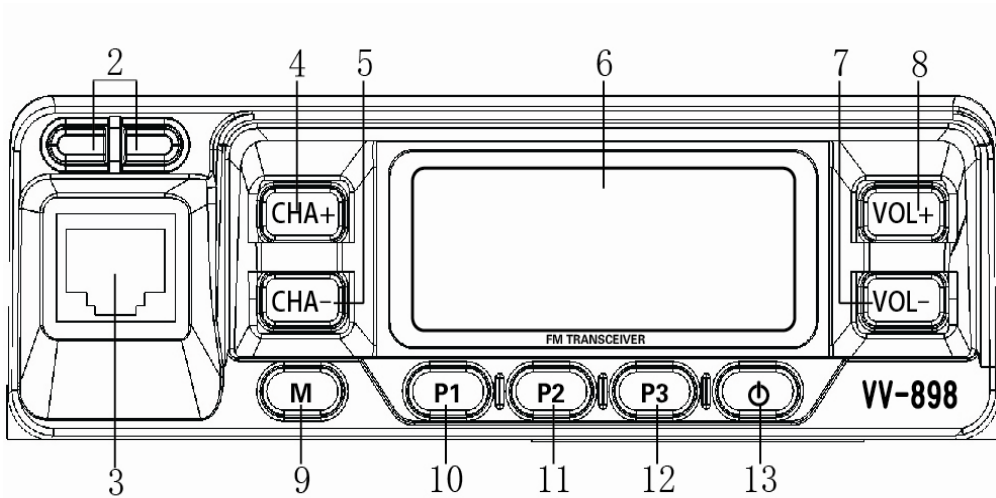

VV-898 Front Panel

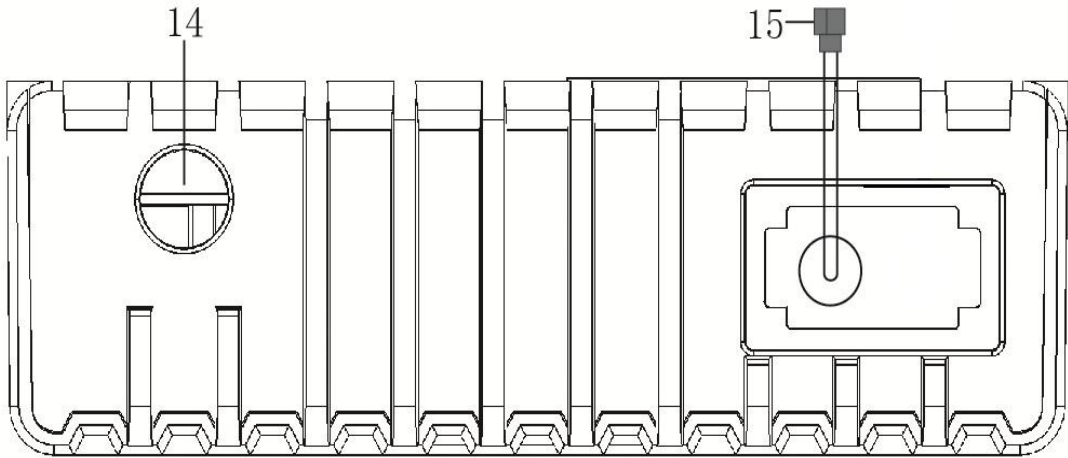

VV-898 Rear Panel

1, Loudspeaker	2, Indicator Light (Red light, green light)
3, MIC Connector (RJ45)	4, CHA+(Channel Up)
5, CHA-(Channel Down)	6, LCD display screen
7, VOL+(Volume Up)	8, VOL-(Volume Down)
9, Menu Key	10, P1 Key (User defined)
11, P2 Key (User defined)	12, P3 Key (User defined)
13,  Power Switch	14, Antenna Connector
15, Power Connector	

DTMF Microphone Panel

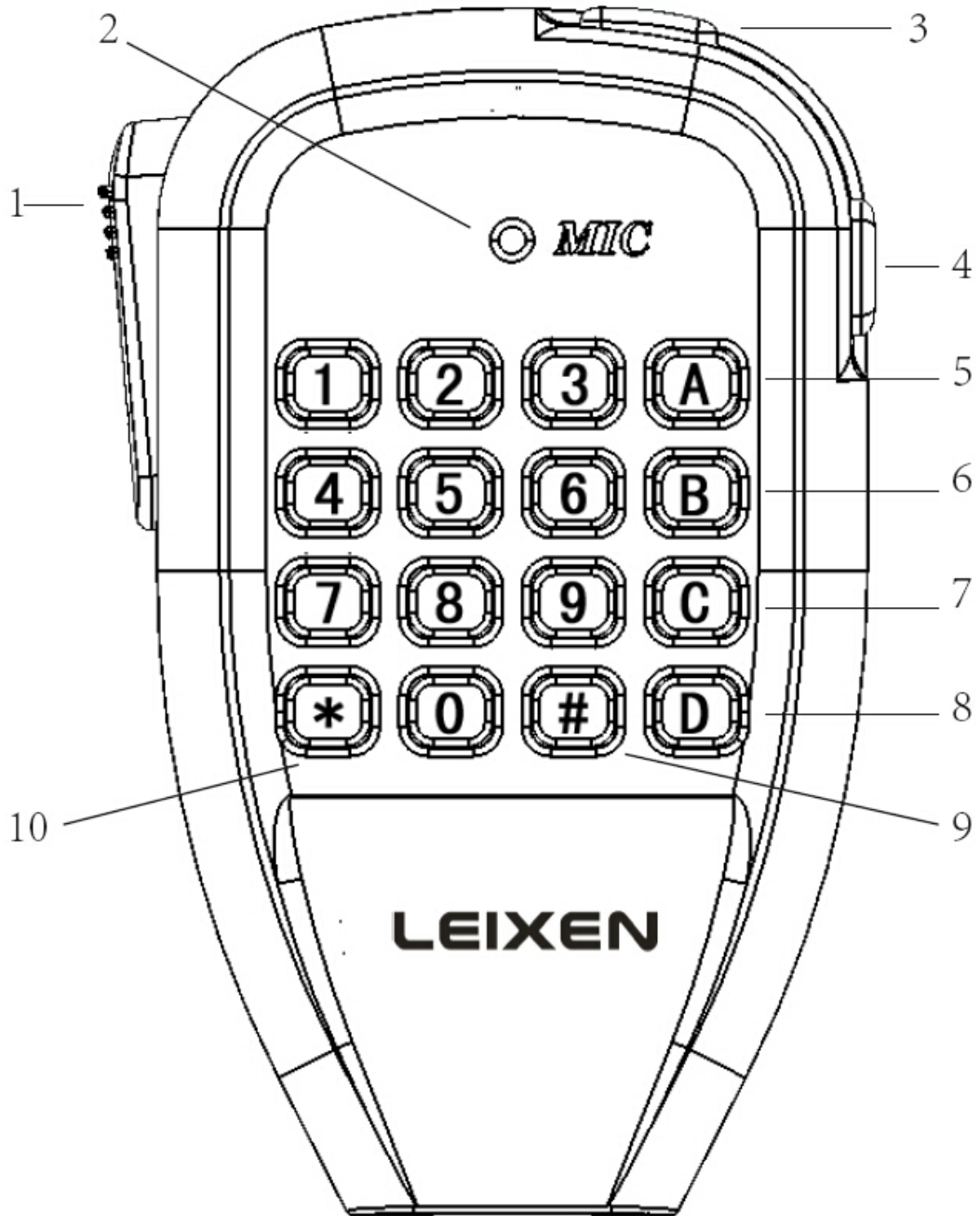

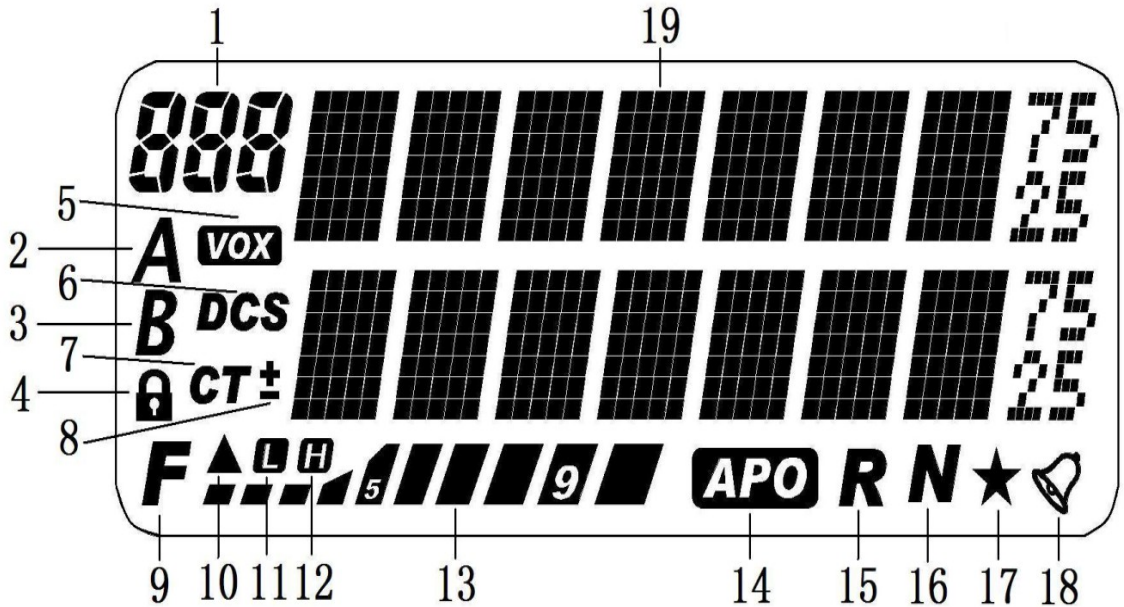

1, PTT	Push to Talk
2, MIC	Microphone
3, UP	Up, VOL+
4, DN	Down, VOL-
5, A	Call
6, B	VFO/MR Switch
7, C	A/B mode Switch
8, D	VFO Band Change
9, #	CHA+
10, *	CHA-

LCD Display



No	Icon	Feature Description	Operation Method
1	000	Memory Channel No.	----
2	A	Being A Channel	Switch A/B Key
3	B	Being B Channel	Switch A/B Key
4		Keyboard Lockout	Press M Key for 2 Seconds
5	VOX	VOX Open	Refer to Menu 45

6	DCS	DCS Open	In VFO/MR mode: Decode Type and Decode Code refer to Menu08 and 09, Encoded Type and Encoded Code refer to Menu 10 and 11
7	CT	CT Open	The same as above (DCS)
8	±	Offset Frequency	Refer to Menu 34 and 35
	F	Wireless Frequency Open	Refer to Page 44
10	▲	Channel scan disabled	Refer to Menu 39
11	L	Low Power	Refer to Menu 30
12	H	High Power	Refer to Menu 30
13		Indicate Power strength when transmitting, 10 grids for high power, 5 grids for small power. Indicate signal strength when receiving.	----
14	APO	Auto Power off	Refer to Menu 01

15	R	Reverse Frequency	Refer to Menu 33
16	N	Narrowband	Refer to Menu 50
17	★	Dual Reception	Refer to Menu 07
18		DTMF	Refer to Menu 06
19		Displayed frequency value, channel names, menu items, and other numbers, letters or symbols Information	----

Front Panel Description



Orient the transceiver with the front panel facing you. Find the RJ-45 microphone jack on the left side of the front panel. To the right of the microphone jack is a column of three buttons. From top to bottom, these are CH+, CH-, and M (Menu). The LCD display is directly to the right of these three buttons.

Below the LCD display is a row of four buttons. From left to right, these are P1, P2, P3, and the power button.

Finally, to the right of the LCD display is a column of two buttons, labeled VOL+ and VOL-.

Basic Operation

Power on/off

Once power is connected, press the  button to turn the transceiver on. Three ascending tones will sound, indicating that the transceiver has correctly powered on. Hold the  key for 2 seconds to turn the transceiver off.

Turn Volume

Press “VOL+” to raise the volume. Press “VOL-” to lower the volume. Hold the key to go fast. The volume is adjusted in 15 steps from 0 (lowest) to 15 (highest). The default setting is 4.

Select Channel

You can select an operating channel in one of several ways:

- 1) Use the programming software to store operating channels ahead of time. You can then access them directly in MR mode, using the channel up/down buttons or the numeric keypad on the microphone.
- 2) Input frequency values by using the numeric keypad in VFO mode.
- 3) Press the “CHA+” or “CHA-” key to select the

frequency in VFO mode. Hold the key to go fast
4) Input channel number by using the numeric keypad
to select memory channel in MR mode.

Note: This transceiver has a dual-watch function, you can switch between A and B channels using the “C” key (A/B switch key) on the microphone keypad. The A channel can only operate in MR/CH mode, while the B channel can be set to either MR/CH or VFO mode. Please refer to page 40-41 regarding the user-defined key function of the A/B switch and the VFO/MR switch.

In VFO mode, the transceiver will store the most recently used frequency in each of its supported ranges. To switch quickly between the transceiver’s supported frequency ranges, press the  key.

Transmitting and receiving

To transmit, press and hold the PTT key of the microphone and speak normally. Release the PTT key to stop transmitting.

-  Please use Low Power whenever possible. If the distance between you and the other station is short, low power (5 watts) should be adequate. Using low power when possible will not only use less power from your battery or power supply, but your transmitter will also produce less heat, increasing the life of your final amplifier.

-
- ⌚ For best voice quality, hold the microphone about 2 IN (5 cm) away from your mouth and speak normally.
 - ⌚ A red LED indicates that the transmitter is active.

Function Menu Operation

To modify settings in the VV-898's settings menu, follow these steps:

- 1) Press the "M" key.
- 2) a, Use the "CHA+" and "CHA-" keys, or the "VOL+" and "VOL-" keys to select the menu option you wish to modify. Hold the key to go fast
b, You can also input menu number directly by using the numeric keypad to select desired menu.
- 3) Press the "M" key to select the menu for modification.
- 4) Use the "CHA+" and "CHA-" keys, or the "VOL+" and "VOL-" keys to select the desired value.
- 5) Press the "M" key to confirm your changes,
- 6) Repeat steps 2-5 above to modify other menu options.
- 7) Finally, when you have made all of your changes, press any of the front panel keys, except "CHA+", "CHA-", "VOL+", or "VOL-", to exit the menu.

Auto Power Off(APO): Menu 01

Auto Power Off will automatically turn the transceiver off after a set length of inactivity. This function is disabled (off) by default. The Auto Power Off interval can be set to 10 minutes, 20 minutes, 30 minutes, 40 minutes, 50 minutes, 60 minutes, 90 minutes, 2 hours, 4 hours, 6 hours, 8 hours, 10 hours, 12 hours, 14 hours, or 16 hours. The transceiver displays a **APO** icon when APO function is enabled.

APRO (APRO): Menu 02

The audio processing menu allows you to set up the compander and voice scrambler. This setting is stored on a per channel basis. Each channel can have a different processing setting. By default all processing options are disabled (Off). You can set this menu to either enable the compander (Comp) or voice scrambler (Scra).

Busy Channel Lock (BC Lock): Menu 03

When a Channel has the “BC LOCK” function enabled, the ability to transmit is disabled on that channel if it is active. You will again be able to transmit on the channel when the channel is quiet. This option can be set to “ON” or “OFF”. The default

setting is OFF.

Key Beep (Beep): Menu 04

This function determines whether pressing keys on the transceiver or DTMF microphone sound an audible confirmation beep when they are pressed. It can be set to “ON” or “OFF”. This feature is turned on by default.

Channel Save (CHASave): Menu 05

Users can save custom frequency as memory channel, so that save time to re-set the frequency parameters. In VFO mode, enter the frequency you want to save, press the M key and press “CHA+/CHA-/VOL+/VOL-” to menu 05 “CHASAVE”, select the channel number which you want to keep after the screen displayed “CHASave TO 001”, then the frequency is saved.

Up to 199 of your favorite or most commonly used simplex or repeater channels can be stored in the VV-898 for quick and convenient recall.

In VFO mode, enter the frequency you want to save by using the numeric keys on the microphone or the “CHA+” and “CHA-” keys. Once you have tuned to your desired frequency, press the “M” key, then press the “CHA+” and “CHA-“, or the “VOL+” and “VOL-“ keys to select menu 05 “CHASAVE”, and

press the “M” key again. Select the channel number you wish to program. The default is 001. Once you have selected the channel to program, press the “M” key again to confirm.

DTMF Function (DTMF): Menu 06

DTMF (Dual Tone Multi Frequency), dual tone multi-frequency, consists of high-frequency group and low frequency group, each group contains four frequencies. A high frequency signal and a low frequency signal superimposed to form a combined signal which representing a number. DTMF signaling has 16 codes, can be set freely. When a radio channel setting of the DTMF enabled, you can send DTMF codes by wireless control to achieve individual call, group call or RX Inhibition, RXTX Inhibition and other functions.

Dual-Tone Multi-Frequency (DTMF) is a signaling method in which two tones are combined to create one of 16 separate codes. These codes represent digits 0-9, plus *, #, A, B, C, and D. The VV-898 can generate and decode DTMF sequences in order to control other equipment, remotely control or inhibit other VV-898 transceivers, or page individual radio users or groups of users. Each of the 199 channels can be individually programmed for DTMF signaling to be enabled or disabled. Note that if DTMF is disabled on a channel,

it can neither be transmitted nor decoded.

✧ **Enable Or Disable DTMF Signaling**

1, In VFO / MR mode, select a frequency or memory channel to modify DTMF signaling. Alternatively, you can enable DTMF signaling in the programming software.

Note:

a), If the transceiver is in CH mode, you can not enable or disable DTMF signaling from the transceiver's front panel. In CH mode, this setting can only be modified from the programming software.

b), In MR mode, each memory channel can be independently set to have DTMF signaling enabled or disabled.

2, Press the “M” key and use the “CHA+” and “CHA-“ or “VOL+” and “VOL-“ keys to select Menu 06. Press the “M” key to open the menu, and select “ON” or “OFF” to enable or disable DTMF signaling. The default setting is ON. Once you have made your selection, press the “M” key to accept the change, followed by the  key to exit the menu.

✧ **Individual call/ group call**

Individual call: Using the VV-898 programming software, set the transceiver's individual ID code. This can be any code of up to 15 characters, using the digits

0-9, *, #, A, B, C, and D. The default transceiver individual call ID code is 1000.

Group Call: Using a group call character in any part of a radio calling sequence will call all radios in a specific calling group. The only radios in the group that will not automatically respond to a group call are transceivers which are either set to selective call only or those which have receive or receive/transmit inhibit enabled. The group character may be *, #, A, B, C, or D. The default group character is A.

Consider the following example.

Set 10 transceivers as follows:

Item	Individual ID	Unite ID	Group ID.
Transceiver 1	80811	C	Group 1
Transceiver 2	80812	C	Group 1
Transceiver 3	80813	C	Group 1
Transceiver 4	80814	C	Group 1
Transceiver 5	80815	C	Group 1

Transceiver 6	80831	C	Group 3
Transceiver 7	80832	C	Group 3
Transceiver 8	80833	C	Group 3
Transceiver 9	80834	C	Group 3
Transceiver 10	80835	C	Group 3

Send the ID code: 80814 to call "Transceiver 4".

Send the ID code: 80832 to call "Transceiver 7".

Send the ID code: 8081C to call all transceivers in Subgroup 1.

Send the ID code: 8083C to call all transceivers in Subgroup 3.

Send the ID code: 808CC to call all transceivers in Group 1 and Subgroup 3 which are both in Group C.

❖ **DTMF code transmission mode:**

1, Automatic transmission: Fill in the DTMF call list in the programming software. In VFO / MR / CH mode, be sure that DTMF Mode is enabled.

Press the CALL key (A key on the DTMF microphone). Select an autodial slot from the list. Press the PTT key to send the selected DTMF sequence. (Note: Slots 0-9 can be entered directly, or

press UP / DOWN keys on the microphone or press “CHA+/CHA- or VOL+/VOL-” on the transceiver front panel to select. Slots 10-15 can only be selected by using the “UP/DOWN” buttons on the microphone or “CHA+/CHA-“ or “VOL+/VOL-“ keys on the transceiver front panel.

2, Manual transmission: If the DTMF autodial list is empty, automatic DTMF transmission is disabled. However, you can manually enter a sequence of DTMF tones manually.

Press the “CALL” key twice, then enter your desired sequence of DTMF tones from the keypad. Finally, press the PTT key to transmit. You will hear the DTMF tones transmit if they were properly entered.

✧ **Remote RX Inhibition and RXTX Inhibition**

RX Inhibition: If RX Inhibit is enabled, the receiver will remain inactive until it receives the correct RX Enable code.

RXTX Inhibition: With RX/TX Inhibit enabled, the transceiver will be unable to receive or transmit until it receives the correct RX/TX Enable code.

Refer to page 46 for more about RX Inhibition and RXTX Inhibition.

Dual Watch (DW): Menu 07

This setting determines whether the dual watch feature is enabled or disabled. With dual watch enabled, the transceiver will monitor two frequencies periodically. Select Menu 07 to modify this function, which can be turned ON or OFF. The default is ON.

Decode Type and Decode Code (Menus 08 and 09)

Using Menus 08 and 09, you may determine what will open the receiver's squelch. Set the "DecType" option (Menu 08) to select the squelch mode:

OFF: Any signal on the channel will open the receiver's squelch.

CTCSS: Only a signal on the channel containing a matching CTCSS tone (one of 58 tones) will open the receiver's squelch.

NDCS: Only a signal on the channel containing a matching normal DCS code (one of 107 codes) will open the receiver's squelch.

IDCS: Only a signal on the channel containing a matching inverted DCS code (one of 107 codes) will open the receiver's squelch.

After you have selected the decode type in Menu 08, select the CTCSS or DCS code in Menu 09 from the following tables. You can press and hold "CHA+/CHA-/VOL+/VOL-" key to go fast.

CTCSS: 56-254.1 Hz (58 groups), NDCS: 107 groups
Normal DCS code. IDCS: 107 groups Invert DCS
code.

CTCSS standard frequency table (58 groups)

56.0	74.4	107.2	156.7	189.9	241.8
57.0	77.0	110.9	159.8	192.8	250.3
58.0	79.7	114.8	162.2	196.6	254.1
59.0	82.5	118.8	165.5	199.5	
60.0	85.4	123.0	167.9	203.5	
61.0	88.5	127.3	171.3	206.5	
62.0	91.5	131.8	173.8	210.7	
63.0	94.8	136.5	177.3	218.1	
67.0	97.4	141.3	179.9	225.7	
69.3	100.0	146.2	183.5	229.1	
71.9	103.5	151.4	186.2	233.6	

DCS Standard Code Table

017	053	125	172	251	315	411	462	565	703
023	054	131	174	252	325	412	464	606	712
025	065	132	205	255	331	413	465	612	723
026	071	134	212	261	332	423	466	624	731
031	072	143	223	263	343	431	503	627	732
032	073	145	225	265	346	432	506	631	734
036	074	152	226	266	351	445	516	632	743
043	114	155	243	271	356	446	523	645	754
047	115	156	244	274	364	452	526	654	
050	116	162	245	306	365	454	532	662	
051	122	165	246	311	371	455	546	664	

Encode Type and Encode Code (Menus 10 and 11)

Similar to the settings for “Decode Type” and “Decode Code” above, using Menu 10, “EncType” and Menu 11”Enc code”, you may determine the CTCSS or DCS code that is used on a particular channel. You may need such a code in order to access a repeater system

or other radio users who have CTCSS or DCS squelch enabled. You may set Menu 10 as follows:

OFF: Disable. The transmitted signal does not send any CTCSS or DCS codes.

CTCSS: Transmit a specified CTCSS tone (one of 56 tones)

NDCS: Transmit a specified normal DCS code (one of 107 codes).

IDCS: Transmit a specified inverted DCS code (1 of 107 codes)

Use Menu 11 to set the desired CTCSS or DCS tone, using the same tables as for Menu 09.

FM Radio Function(FM): Menu 12

This transceiver has a built-in FM broadcast receiver. You may listen to FM radio broadcasts using this transceiver. To turn the FM broadcast radio on or off. FM frequency range: 87.5-108MHz.

In VFO / MR / CH mode, press the “M” key, then press “CHA+/CHA-“ or “VOL+/VOL-” keys to select Menu 12, then press “M” key to turn on the FM broadcast radio. To turn off again, follow the same procedure.

Open/Close FM Function

-
- ✧ You can set the P1, P2, or P3 key as the shortcut key to turn the FM radio on or off.
 - ✧ With the FM radio turned on, use “CHA+/CHA-” keys to select a station, or enter the station’s frequency directly from the numeric keypad on the microphone. You can also store your favorite radio stations using the VV-898 programming software.

Note: To ensure good FM reception, please connect an antenna to the transceiver.

FM DualWatch (FM DW): Menu 13

The FM Dual Watch feature allows you to continue listening to an FM broadcast station at the same time as another signal from the transceiver is present. If this feature is disabled, a signal from the main transceiver will interrupt FM broadcast radio reception. In either case, pressing the PTT will interrupt FM broadcast reception. This feature may be turned ON or OFF through Menu 13. The default setting is ON.

FM Scan(FM Scan)): Menu 14

The FM Scan function determines whether the “CHA+/CHA-“ keys scan for active FM channels or

simply tune the radio in 50 KHz tuning steps. Setting FM Scan (Menu 14) to ON will increase tuning speed, as only active FM radio signals will stop tuning.

FM SQL (FM SQL): Menu 15

The FM SQL menu determines the sensitivity of the FM broadcast scan. The higher this setting, the stronger a signal must be in order for the scan to stop on a particular FM broadcast channel. Settings range from 0 (always on) to 9 (tightest squelch for scan). The default level is 5.

Font size (Choose (Font): Menu 16

You can select the font size of the channel display through this menu. Select “BIG” to show both channels in a larger font. Choose “SMAL” to have the active channel in a larger font and the second channel in a smaller font. The default setting is SMAL.

Note: “BIG” font can only be set if Channel Alias is also set as active.

Key Lock Function (Keylock): Menu 17

You may lock the transceiver controls by holding the “M” key for one second. When the lock is enabled, the  symbol appears. Unlock the transceiver controls by again holding the “M” key for one second.

You can choose what controls are locked through Menu 17 as follows:

KEY: Numeric and function keys, keys on the microphone and the front panel of transceiver, excluding the “M” key and the  key.

K + S: KEY + DIAL. Numeric +function keys + “CHA+/CHA-/VOL+/VOL- excluding the “M” and  keys

PTT: PTT Key.

ALL: KEY + DIAL + PTT excluding “M” key and  key

Default is K + S.

Keypad Function(Keypad): Menu 18

Menu 18 is set depending on which microphone shipped with your VV-898 transceiver. If you received the DTMF microphone, set this menu to ON. Setting to OFF will not allow you to use the keys on the DTMF microphone. If you did not receive the DTMF microphone, for power conservation, we recommend you set this menu to OFF. The default setting is ON.

Backlight (Lamp): Menu 19

You can set backlight behavior through Menu 19. Select from the following settings:

OFF: Backlight is disabled

KEY: Backlight is active only when a key is pressed.
CONT: Backlight is always enabled. The default setting is CONT.

Setting Channel Names: (Name): Menus 20 /21/22

Menu 20 determines whether the transceiver allowed the user-defined channel name displayed or not. If it is enable, all channel would display user-defined channel name, if it is disable, all user-defined channel name would not be displayed.

Menu 21 determines whether a user-defined channel name will be displayed. Set this option to ON if you would like to see channel names instead of merely channel numbers. The default is OFF.

It may be helpful for you to name particular channels with meaningful labels, such as call signs, cities, or channel use. Your channel names can be up to seven characters long.

You can edit channel names using Menu 22. Access Menu 22, press P2 to edit the first digit, press “CHA+/CHA-/VOL+/VOL-” to select the character desired, then press P2 to confirm and edit next digit, after edit all digit desired, press P3 key to end edit and press Menu key to exit. The default label for any channel is “Name***”. You may use any of the characters in the following table in your channel names. You can press and hold

“CHA+/CHA-/VOL+/VOL-” key to go fast.

Edit Alias valid characters:

A	B	C	D	E	F	G	H	I	J	K	L
M	N	O	P	Q	R	S	T	U	V	W	X
Y	Z	[¥]	^	-	`	a	b	c	d
e	f	g	h	i	j	k	l	m	n	o	p
q	r	s	t	u	v	w	x	y	z	{	
}	→	←	space	!	"	#	\$	%	&	'	(
)	*	+	,	-	.	/	0	1	2	3	4
5	6	7	8	9	:	;	<	=	>	?	@

Set Opening Display (OpenDIS): Menu 23

You can select what displays when the transceiver first powers on by using Menu 23. Choose from the following options:

ALL: Boot displayed as full screen display.

SYS: Boot displayed as system welcome word.

User: Boot display as User-defined word.

You can set the user-defined word in the programming software.

Time: Boot display as remaining lease time.

The default setting is USER.

Custom Keys Set (P1-P3、 M Key): Menus 24-29

You can define the shortcut function directly through software. Default of M short press is to enter the Menu.

Default of shortcut keys:

P1 Long Press: FM (FM radio)

P1 Short Press: Time (Time display on screen)

P2 Long Press: MOLO (Monitor Lock)

P2 Short Press: Bandchange(Change band)

P3 Long Press: SCAN (scan)

P3 short Press: MUTE (mute)

M Short Press: Enter the menu function

Several keys on the front panel of the VV-898 are user programmable. Each key has two possible functions, defined in Menus 24 through 29.

Key functions are accessed via a short press (press and release) or long press (press and hold for 1.5 seconds by default, although this time can be adjusted in the programming software).

Please refer to Page 37 for details of setting up these programmable shortcut keys.

While functions for short and long press of Keys P1, P2, and P3 are defined in Menus 24 through 29, the M key is a special case. The short press of the M key can only be defined in the programming software, since its default behavior is to access the VV-898 setup menu.

The M long press is not user defined, as it locks or unlocks VV-898 keys and/or PTT. (See “Keylock”, Menu 17, for details.

The default functions of the programmable keys are as follows:

P1 Long Press: FM (FM transceiver)

P1 Short Press: Time (Time display on screen)

P2 Long Press: MOLO (Monitor Lock)

P2 Short Press: Bandchange (Change band 136/245/400 MHz)

P3 Long Press: SCAN (scan)

P3 short Press: MUTE (mute)

M Short Press: Enter the menu function

High/Low Power Set (Power): Menu 30

You may select your desired transmit power level from Menu 30. For communication with nearby stations, we recommend that you use low power. This will produce less heat and prolong the useful life of the final amplifier. For stations that are more distant, you should use high power for improved communication clarity. High power is the default setting.

PTT ID (PTT ID): Menu 31

PTT ID allows you to send a code that identifies your

specific transceiver. The PTT ID code is defined in the programming software; the default ID is “123”.

You can also set whether PTT ID’s are spoken or displayed. If voice is selected, ID’s of up to five digits will be spoken. However, up to 14 digit ID’s can be displayed if voice ID’s are disabled.

Each channel stores whether the PTT ID is enabled.

To enable PTT ID:

In VFO / MR mode, choose the frequency or channel on which you would like to enable the PTT ID.

Set Menu 31 to ON if you would like to enable the PTT ID, or OFF to disable it.

Note:

- a) In CH Mode, you may not modify this setting.
- b) In MR mode, each memory channel can be individually programmed to enable or disable PTT ID.

You may also use the programming software to enable or disable PTT ID for any channel.

The PTT ID can be sent:

1. At the beginning of the transmission: The ID is sent immediately when the PTT key is pressed.
2. At the end of the transmission: the PTT ID is sent when the PTT key is released.
3. Both: the PTT ID is sent both when the PTT key is pressed and again when it is released.

ROGER(ROGER): Menu 32

The VV-898 can send a “Roger beep” to mark the end of a transmission. Select Menu 32, and select “ON” to enable this feature, or “OFF” to disable it. The default setting is OFF.

REVERSE (REVERSE): Menu 33

The Reverse feature can only be enabled if Offset Frequency and RPT Type, Menus 34 and 35, are also set. The Reverse function swaps the receive and transmit frequencies so that you can hear another transceiver’s calls directly rather than through a repeater. This would be useful in order to determine whether you can establish direct contact with a nearby station, freeing up the repeater for other uses.

To set the Reverse function, set Menu 33 to “ON”. To return to normal operation, set Menu 33 to “OFF”.

Offset Frequency (RPT SET/RPT TYPE): Menus 34 and 35

You can set a channel to use different receive and transmit frequencies. This is most useful for operating through a repeater, which receives on one frequency and then retransmits on another frequency from a higher antenna. This effectively provides systems

using the repeater with greater communication range than they would achieve alone.

Setting these separate frequencies is accomplished by setting Menus 34 and 35. First, you will need to set the offset amount, which is the difference between the receive and transmit frequencies. The VV-898 can accept offset values from 0.000 to 399.995 MHz.

In VFO Mode, select Menu 34. Enter the offset value using the number keys on the DTMF microphone, or by using the “CHA+/CHA-“ or “VOL+/VOL-“ keys.

Select the offset direction using Menu 35. Using the “CHA+/CHA-“ or “VOL+/VOL-“ keys, select “RPT+” (positive offset, the transmit frequency is higher than the receive frequency), “RPT-” (the transmit frequency is lower than the receive frequency), or “SING” (no offset, only a single frequency is used).

For example: In VFO mode, enter a frequency such as 450MHz, and set the offset to 5MHz. If RPT Type is “+RPT”, then the receive frequency is 450MHz, and the transmit frequency is 455MHz; if RPT Type is “-RPT”, then the receive frequency is 450MHz, and the transmit frequency is 445MHz; if RPT Type is “SING”, receive and transmit frequency are both 450MHz.

Note: Offset frequency setting is only available in VFO mode. It cannot be set in already programmed memory channels.

When using the programming software, you must specify both receive and transmit frequencies directly.

Save Battery (SaveBat): Menu 36

Battery Save mode lowers current consumption by putting the receiver in a low power “sleep” mode periodically during quiet periods with no received signals. Set Menu 36 ON to enable this function, or OFF to disable it. The default setting is ON.

Scan (SCAN): Menus 37, 38, and 39

Scan mode allows you to monitor several channels more efficiently. Channels are scanned until activity is detected on a channel. Depending on the scan mode, scanning may continue after a specific length of time, or it will only continue when the channel is inactive.

Scan Mode: Select the scan mode in Menu 38. There are two modes:

- ✧ Time operated (TO): Scanning stops when an active channel is encountered. The scan will pause for five seconds, then scanning will continue, even if the channel is still active.
- ✧ Carrier operated (CO): Scanning stops when an active channel is encountered. Scanning resumes after two seconds of channel inactivity.
- ✧ The default setting is “TO”.

Note: Press any key except “UP”, “DOWN”, “CHA+/CHA-“, or “VOL+/VOL-“ to stop scanning.

Scan Type: You may choose two different scanning modes:

✧ VFO frequency scan: All frequencies on the band will be scanned.

In VFO mode, select Menu 37 and press M key to start scanning. The scan will begin at the current frequency and continue up the band. To reverse the scan direction, press the “DOWN” key, the “CHA-“ key, or the “VOL-“ key. Scan up the band again by using the “UP” key, the “VOL+” key, or the “CHA+” key. Press any other key to stop scanning.

✧ MR/CH scan: Scan only programmed memory channels in this mode. From MR/CH mode, select Menu 37, and press the “M” key to start the scan. Scanning begins on the current channel and scans up to higher channel numbers. To reverse the scan direction, press the “DOWN” key, the “CHA-” key, or the “VOL-“ key. Scan up the band again by using the “UP” key, the “VOL+” key, or the “CHA+” key. Press any other key to stop scanning.

Note:

1. Each memory channel can be set to be blocked from scan through Menu 39. If Scan Add is

disabled on a channel, that channel will be skipped during MR/CH scans. A channel's scan status will be indicated on the transceiver's display.

2. MR/CH Scan is only available if two or more channels are programmed with Scan Add enabled.
3. Scan is only effective if the squelch is closed.

Squelch Level (SQL): Menu 40

The squelch circuit allows you to only hear desired signals. If a strong enough signal is not present, the squelch circuit is closed, and you will hear no background noise. Higher levels of the Squelch level setting require stronger signals to open the squelch circuit. Set the squelch level to one appropriate to the amount of RF noise in your environment. A squelch setting that is too high may cause you to miss receiving a weaker signal, while too low a setting may cause you to hear more noise than you might want.

Set the Squelch Level using Menu 40. There are nine levels of squelch setting; the default level is 2.

Step (Step): Menu 41

Step is the value in which the operating frequency increases or decreases with presses of the "Up", "Down", or "CHA+/CHA-" keys in VFO mode. Select the Step in Menu 41. Valid step sizes are 2.5, 5, 6.25, 10, 12.5, and 25 KHz. The default is 25 KHz.

Tail Elimination (Tail): Menu 42

The Tail elimination function eliminates the burst of background noise encountered at the end of a transmission. . Set Menu 42 to ON if you would like to enable this feature, or OFF to disable it. The default is ON.

Talk Around (Talk): Menu 43

When the Talk around feature is enabled, the transmit and receive frequency and signaling mode are the same. This would be useful if two stations who are close together wish to temporarily use the output frequency of a repeater. Turn Menu 43 ON to enable this feature. The default is OFF.

Time out timer(TOT): Menu 44

You may use Menu 44 to specify a time-out timer for the transmitter. Setting such a timer would prevent accidental, lengthy transmissions where the transmitter does not properly unkey(a stuck PTT key, for instance). Not only could such transmissions be disruptive to other communications, they could damage the transmitter. Select Menu 44, and set the Time-Out Timer to OFF, or in 10-second intervals of up to 120 seconds. The default setting is 30 seconds.

TX Stop (TXStop): Menu 45

The TXStop function disables the transmitter when it is enabled. If TXStop is enabled, pressing the PTT key will issue an audible alert tone, indicating that you are unable to transmit. Select Menu 45, and set it to ON if you would like to enable this feature. The default setting is off.

VOX (VOX): Menus 46-49

VOX, or Voice-Operated Transmit, allows you to transmit by simply speaking into the microphone. With VOX enabled, you won't need to press the PTT key to enable the transmitter. Use Menu 46 to turn VOX ON or OFF. The default is OFF.

VOX S (Sensitivity):

VOX Sensitivity determines the level of sound that is needed for the VOX to key the transmitter. You should experiment with VOX Sensitivity to find a level that is appropriate to your voice but does not trigger on the presence of too much other background noise. Set Vox S using Menu 47. There are eight possible levels. The default level is 3.

VOX D(Delay):

VOX Delay determines the delay to stop transmitting after you finish speaking. Set the VOX Delay in Menu 48. Too short a delay will cause the transmitter to

unkey too frequently. Delay can be set from 1 to 4 seconds; the default setting is 3 seconds.

VXB (VOX inhibited when receiving):

Set Menu 49 to ON if you do not want VOX active while the receiver is active. To avoid the receiver keying the VOX by mistake, it is probably a good idea to leave this setting at its default ON state.

Wide and Narrow Bandwidth Set (WidNar): Menu 50

You can set the channel bandwidth to “WIDE” or “Narrow” using Menu 50. Set this according to your country or radio service regulations. The default setting is WIDE.

User-defined Keys Menu

As previously mentioned the P1, P2, P3, and Menu keys are user programmable. While the short press of the M key can only be changed in the programming software, the P1, P2, and P3 keys can be programmed using Menus 24-29.

Each of these keys has two programmable functions, accessed by a short press (press and release) or a long press (Press and hold for 1.5 seconds). Each of these functions is set in one of the programmable key menus.

Note: If you would like to change the hold time for Long Press, you may do so using the programming software.

You may set any of the programmable keys to perform the following functions:

OFF

If a shortcut key is disabled, it is not usable unless Wireless Change Frequency is enabled. Please refer to Page 44 for details.

FM (FM)

Setting a shortcut to FM toggles the FM broadcast radio on or off.

Band change (Bandchange)

In VFO Mode, the Band Change button switches between the last used frequencies on 136 MHz, 245 MHz, or 400 MHz.

Time of system (Time)

Setting a shortcut to TIME will display the system time. There is a built-in button cell (CR2032) which supply power to continue timing system time when the radio power off. Normally the button cell can use several years, but you can change a new CR2032 when it is used out.

Note: The system time can only be set though program software.

Monitor Momentary (MONI)

Setting a shortcut key to MONI will allow you to temporarily open the receiver squelch, in order to hear a weak signal that cannot break through at the current squelch setting. Pressing MONI will open the receiver's squelch, and releasing will close it again.

Note: MONI can only be set as Long press.

Monitor Lock (MOLO)

Setting MOLO will open the squelch to allow you to listen for weaker signals. Pressing the MOLO shortcut will open the squelch, while pressing it again will close the squelch again. If MOLO stays active for more than 10 seconds, squelch will automatically close.

SQ OFF Momentary (SQM)

If the SQM shortcut is enabled, pressing it will disable any CTCSS or DCS squelch, allowing any signal to activate the receiver. Pressing this key will issue an audible alert indicating the feature is active. Pressing the key a second time will sound a different alert to indicate that the receiver is in its normal state.

Note: SQM can only be set as Long press.

Mute (MUTE)

When the Mute shortcut is enabled, pressing the Mute key will disable audio from the receiver's speaker. Press the key again to unmute the speaker.

Scan (SCAN)

Pressing the LOW shortcut will toggle the power level between HIGH and LOW power.

High/Low Power (LOW)

Pressing the LOW shortcut will toggle the power level between HIGH and LOW power.

Emergency (EMG)

The EMG key will sound an emergency alarm. When this alarm sounds, the indicator LED's will alternate between flashing red and green and "TX STOP" will display on the screen. This mode will remain in force until the PTT is pressed or the transceiver is powered down.

V/M Mode Switch (V/M)

The VM shortcut will toggle the B operation between VFO and MR mode.

DTMF Function (DTMF)

The DTMF shortcut will turn DTMF Mode on or off.

Call (Call)

The CALL shortcut will toggle the CALL function on and off.

Transmit 1750Hz (1750Hz)

The 1750Hz shortcut will transmit a 1750Hz burst tone when pressed.

A/B Mode Switch (A/B)

The A/B shortcut will toggle between the A and B channel.

Talk Around (Talk)

The Talk Around shortcut turns Talk Around mode on or off.

Reverse Frequency (Reverse)

The Reverse shortcut enables or disables Reverse frequency mode.

Reset Menu

All Reset

All Reset resets the transceiver to all factory settings, leaving only the DTMF dial list untouched.)

To perform an All Reset, press the  key to turn the transceiver on. When the welcome screen is displayed, hold the M key for two seconds. The screen will display “Menu 0/ALL RES? “. Press the M key again and the screen will display “RESET”. Press the M key a third time, and the screen will display “Waiting”. When the transceiver restarts, the reset is complete. Note: You may cancel the reset by pressing any key other than the “M” key when the “Reset?” prompt appears.

Function Reset

Function Reset will reset the transceiver to factory default settings, leaving memory channels and the DTMF list intact.

To perform a Function Reset, press the  key to turn the transceiver on. When the welcome screen is displayed, hold the M key for two seconds. The screen will display “Menu 0/ALL RES? “. Use the microphone’s UP/Down keys, or the

“CHA+/CHA-“ or “VOL+/VOL-“ keys to select “Menu 1 FUN RES”. Press the M key again and the screen will display “RESET”. Press the M key a third time, and the screen will display “Waiting”. When the transceiver restarts, the reset is complete. Note: You may cancel the reset by pressing any key other than the “M” key when the “Reset?” prompt appears.

Programming Operation

Lease Function

The Lease function can be set to limit how long a transceiver can be used. When the Lease Time expires, the transceiver will no longer operate, and the indicator LED will light continuously red. At this point, the user may only turn the transceiver power off. This function can only be reset with the VV-898 programming software.

Remaining time: You can set the transceiver to display the time remaining for the transceiver lease. If the Lease function is enabled using the programming software, the startup display can be set to display the remaining lease time.

Lease Time: You may set the transceiver Lease Time through the programming software. The valid Lease Time range is from 1 minute to 255 days 24 hours, and 59 minutes.

Wireless Change Frequency

Wireless Frequency Change is a feature that allows VV-898 transceivers to be programmed with new frequency information remotely. In other words, one master transceiver can program several deployed transceivers in the field by sending the appropriate commands over the air.

Consider the following example:

A team bought 10 transceivers. One is used at the home office, while the other nine are installed in company cars. The home office needs to add a new communications channel to all deployed radios. Thus, the staff at the home office may use Wireless Frequency Change to program all the radios remotely without having to do them one at a time and without having to recall them back to the home office for programming.

Refer to details as following:

- 1) First, all transceivers should have Wireless Frequency Change enabled on all 10 transceivers ahead of time. This is accomplished using the programming software. Additionally, set a 1-15 digit activation code using DTMF digits 0-9 plus *, #, A, B, C, and D.
- 2) Program one of the programmable shortcut keys to OFF, so that it can be used to access the Wireless

Frequency Change function.

- 3) The transceiver at the home office should be programmed as the “master” transceiver. It should also have a DTMF microphone.
- 4) The new channel should be programmed into one of the master transceiver’s 199 channels. For our example, we’ll program it into Channel 03.
- 5) When all transceivers are prepared for the changes, the change can be accomplished manually or automatically:
 - a), Manually change frequency: Alert the other nine transceivers that a frequency change is ready to be programmed. The operators of those nine transceivers would press the shortcut key to enable the transfer. An icon “**F**” will appear acknowledging that the transceiver is ready for programming. The master radio would initiate the change using the instructions in Step 6 below. Once programming is complete, the icon “**F**” will disappear. If it does not disappear, programming was not successful. Once programming is successful, the remote users can switch to the newly programmed channel.
 - b), Automatically changing frequency: Alert the other nine transceivers that a frequency change is ready to be programmed. The master transceiver then sends the Wireless Frequency Change Enable code. When this is received, an icon “**F**” will appear to

acknowledge the remote transceivers are ready for programming. The master radio would then initiate the change using the instructions in Step 6 below. Once programming is complete, the icon “**F**” will disappear. If it does not disappear, programming was not successful. Once programming is successful, the remote users can switch to the newly programmed channel.

- 6) Changing operation: On the master transceiver, press the Call key (“A” on the DTMF microphone). “Send 01” appears on the screen. Use the “CHA+/CHA-“ or “VOL+/VOL-“ keys to select the channel you wish to program, such as Channel 003, then press the PTT key. Press the “A” key again. This will display “Send 03”. Press the PTT to send the second programming code. If the icon “**F**” disappears, programming was successful.

RX Inhibit/RXTX Inhibit

RX Inhibition: When RX Inhibit is enabled, the receiver will be inactive until the correct RX Enable code is received. While the transceiver is in RX Inhibit mode, pressing the PTT key will also produce an error tone.

RXTX Inhibition: When RX/TX Inhibit is enabled, the transceiver will remain completely inactive; it will

neither receive nor transmit until the correct RX/TX Enable code is received. If you attempt to transmit while RX/TX Inhibit is in force, the transceiver will not indicate transmission, and it will produce an error tone.

RX inhibit and RXTX inhibit And Reactivate Codes: These codes are up to 15 characters long, using 0-9, A-D, * and #.

To activate RX Inhibit or RX/TX Inhibit, use the programming software to enable the appropriate settings and assign the appropriate Inhibit and Reactivate codes. You can then send the Inhibit or Activate codes using another transceiver that has DTMF capability.

Note: If “Activation Enable” hasn’t been checked, the transceiver cannot be activated over the air with a reactivation code. In this case, it can only be reactivated through the programming software.

Setting Transmission Limits Per Minute

To prevent users from transmitting too often and potentially disrupting communications, you can limit the number of transmissions allowed during one minute period. Set this from 0 (No limit) to 255 in the programming software. If a limit is set and that limit is exceeded, the transmitter will issue an error tone and will not transmit until the timer resets.

Maintenance

Base Knowledge

This transceiver has been strictly and carefully calibrated and tested at the factory to ensure that it meets our stated specifications. Please refer any service issues to authorized repair facilities. Any tampering, user performed maintenance or adjustment of the transceiver will void your warranty. Please refer any service or maintenance concerns to LEIXEN or a LEIXEN authorized dealer.

Cleaning and Maintenance

- 1) Handle this equipment with care. Do not carry the transceiver by its power cable, microphone, or antenna.
- 2) Use a soft, clean, dry cloth to clean the transceiver.
- 3) When storing the transceiver, avoid temperature extremes of heat or cold. Extreme temperatures may shorten the life of the transceiver.
- 4) After prolonged use, the transceiver may require cleaning. Use only mild detergents. Do not use any corrosive or harsh chemical cleaners. Using alcohol, oil or spray chemical agents may damage the transceiver casing.

5) Please use only approved antennas. Unauthorized antennas or modified accessories could damage the transceiver or violate regulations governing RF devices.

6) Please back up all settings and programmed data from your transceiver before sending it in for repair.

7) If your transceiver is defective or develops a problem, please send it only to Leixen or a Leixen authorized service center. Please contact your local dealer for assistance.

We strived to write content of the manual accurately and completely, but it might still possible has existence of errors and omissions. **LEIXEN** company does not assume any responsibility. **LEIXEN** Company keeps right to change product design and specifications at any time. As technology developing, design and product specifications are subject to change without notice.

Specification

Model	VV-898: Dual Band
TX Frequency	400~470MHz/136~174MHz
RX Frequency	400~520MHz/136~174MHz/ 200-260MHz/87.5-108MHz
Channel Capacity	199
Output Power	4W/10W
Operation Mode	Half-Duplex
Dimension (L*W*H)	120×90×40mm
Weight	315g
Modulation Limitation	≤±5KHz
Spurious Radiation	60dB
TX Current	1A/1.8A
Frequency Stability	±2.5PPM
Rx Sensitivity	<0.18μV
Modulation Type	F3E
Audio Power	≥400mW
Standby Current	78mA(Power Saving mode is 30mA)
Rated Voltage	13.8V



泉州雷讯电子有限公司
[HTTP://WWW.LEIXEN.COM](http://www.leixen.com)